

TIMKEN

TIMKEN® SNT SPLIT PLUMMER BLOCKS



Stronger. **By Design.**

TABLE OF CONTENTS

INTRODUCTION.....	3
TIMKEN SNT SPLIT PLUMMER BLOCKS.....	4
SEAL OPTIONS AND DESCRIPTIONS.....	6
SEAL SELECTION AND CONFIGURATION EXAMPLE.....	7
SNT NOMENCLATURE: 200-300 AND 500-600 SERIES; 3000 AND 3100 SERIES.....	8
HOUSING STRENGTH.....	10
RADIAL INTERNAL CLEARANCE.....	11
SHAFT LENGTH GUIDELINES.....	13
TWO-BOLT SNT HOUSINGS FOR TAPERED BORE BEARINGS – 500/600 SERIES.....	14
FOUR-BOLT FSNT HOUSINGS FOR TAPERED BORE BEARINGS – 500/600 SERIES.....	18
TWO-BOLT SNT HOUSINGS FOR CYLINDRICAL BORE BEARINGS – 200/300 SERIES.....	22
FOUR-BOLT FSNT HOUSINGS FOR CYLINDRICAL BORE BEARINGS – 200/300 SERIES.....	26
FOUR-BOLT SNTD HOUSINGS FOR TAPERED BORE BEARINGS – 3000 AND 3100 SERIES.....	30
FOUR-BOLT SNTD HOUSINGS FOR CYLINDRICAL BORE BEARINGS – 3000 AND 3100 SERIES.....	36
SNTN HOUSINGS FOR TAPERED BORE BEARINGS – 3000 LIGHT SERIES.....	38
SNTN HOUSINGS FOR CYLINDRICAL BORE BEARINGS – 3000 LIGHT SERIES.....	40





A SINGLE SOLUTION HOUSED IN STRENGTH

Stronger outside. Smarter inside.

Accelerate your efficiency with Timken® SNT Plummer Blocks that keep lubrication in and contamination out. With a split-design cast iron or ductile iron housing outside and Timken® High-Performance Spherical Roller Bearing inside—you'll put an integrated bearing solution of the highest integrity to work.

- **Engineered Housings:** No matter the size, our durable housings are engineered to perform. The large sizes (3000 and 3100 series) come standard in ductile iron for your toughest applications.
- **Timken® Spherical Roller Bearings:** Gain longer bearing life through premium performance from increased load-carrying capacity and cooler running temperatures.
- **Four Seal Options:** Choose from double-lip, labyrinth, V-ring or taconite designs.
- **Effective Lubrication:** The lubrication system features a center-mounted grease fitting matched to the bearing lube ring and holes, along with options for other grease fitting locations.
- **Flexible Configurations:** With many options to choose from, there's a Timken SNT split plummer block solution to meet all your needs. Depending on your accessories, a single housing can be utilized for a variety of bearings based on capacity needs, in fixed or float positions, and open or closed with end covers.

TIMKEN SNT SPLIT PLUMMER BLOCKS – STRONGER OUTSIDE

Timken engineered split plummer block solutions deliver performance, productivity and efficiency.

SPLIT-BLOCK HOUSINGS

Provide proper support with precision-fit matched and serialized cap-and-base that are dowel-pin aligned. Simplifies installation of heavy housings. Convenient pry-tool slots for easy cap removal, speedy bearing inspection and replacement.



SEAL OPTIONS

Help keep interior contact surfaces debris-free and properly lubricated with strong and effective seals. Timken double-lip, labyrinth, V-ring and taconite seal options increase bearing life and improve uptime.

OPTIONAL END COVERS

Avoid damage to bearing and housing with easy to install end covers.

TAPERED ADAPTER OR STRAIGHT BORE MOUNTING

Secure each bearing onto the shaft.

STANDARD METRIC MOUNTING DIMENSIONS

Easy installation with industry standard dimensions for bolt holes, center height and shaft diameter. Conforms to ISO 113:1999.

CAST IRON AND DUCTILE IRON

Timken SNT split plummer block housings are produced with high-quality cast iron or ductile iron.

Cast iron (gray cast iron) is the standard material for the 200–300 and 500–600 series housings. Cast iron has good wear resistance, high vibration absorption (damping) properties, good thermal conductivity and is suitable for many industrial applications.

Ductile iron (spheroidal or nodular graphite cast iron) is the standard material for the 3000 and 3100 series. Ductile iron, also known as SGI, has more impact and fatigue resistance than cast iron due to the graphite nodules. Ductile iron housings can support loads higher than gray cast iron.



LOCATING RINGS

Provide flexibility to fix or float the bearing.

HOUSING MATERIALS

Rugged cast iron and ductile iron are well-suited for harsh industrial applications. The 200–300 and 500–600 series are furnished in cast iron. The large 3000 and 3100 series come standard in ductile iron.

LUBRICATION

Enhance the performance of our split plummer block solutions with Timken grease and single-point lubricators. Learn more at <http://www.timken.com/en-US/products/lubrication>.

3D CAD and 2D drawings available at <http://cad.timken.com/category/snt-housed-units>

TIMKEN SPHERICAL ROLLER BEARINGS — SMARTER INSIDE

Timken® Spherical Roller Bearings are engineered to give you more of what you need.

LOWER OPERATING TEMPERATURES

Rollers are guided by cage pockets—not a center guide ring—eliminating a friction point and resulting in **4–10% less rotational torque and 5° C lower operating temperatures.***

TOUGHER PROTECTION

Hardened steel cages deliver greater fatigue strength, increased wear resistance and **tougher protection against shock and acceleration.**

OPTIMIZED UPTIME

Unique slots in the cage face improve oil flow and purge more contaminants from the bearing to help **extend equipment uptime.**

MINIMIZED WEAR

Improved profiles reduce internal stresses and **optimize load distribution to minimize wear.**

IMPROVED LUBE FILM

Enhanced surface finishes avoid metal-to-metal contact to **reduce friction and result in improved lube film.**

HIGHER LOADS

Longer rollers result in **4–8% higher load ratings or 14–29% longer predicted bearing life. Higher load ratings enable you to carry heavier loads.**

Brass cages are available in all sizes; ready when you need extra strength and durability in the most unrelenting conditions, including extreme shock and vibration, high acceleration forces, and minimal lubrication. Typically, SNT housings use spherical roller bearings with C3 or C0 clearance. Timken offers a wide variety of clearances to meet your application needs.

**All results are from head-to-head testing against multiple competitors.*

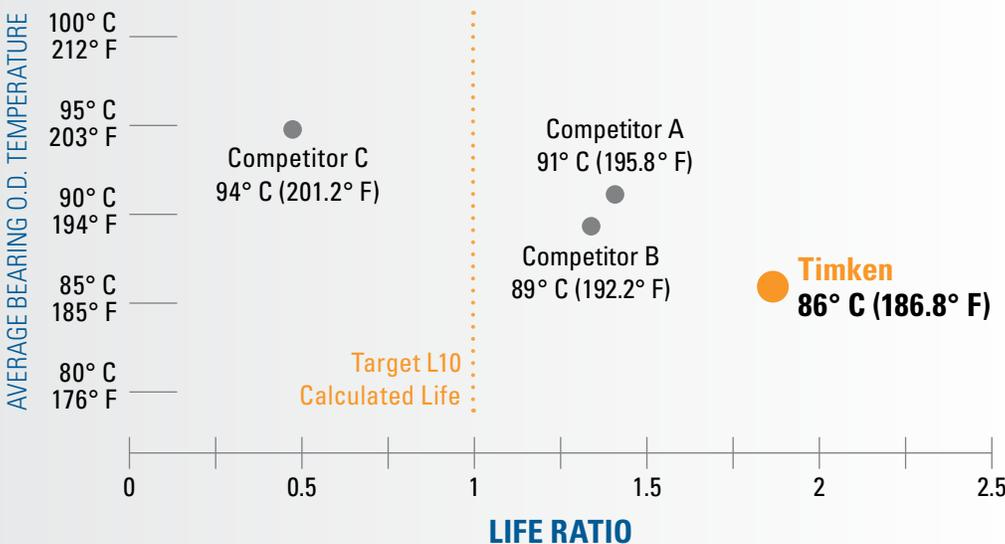

Tested 22212 at 2700 rpm with a load ~25% of the dynamic capacity.

Increase your operational efficiencies and extend maintenance intervals.

Starting now.

Visit

[Timken.com/spherical](https://www.timken.com/spherical)
to find out more.

SEAL OPTIONS: 500–600 AND 200–300 SERIES

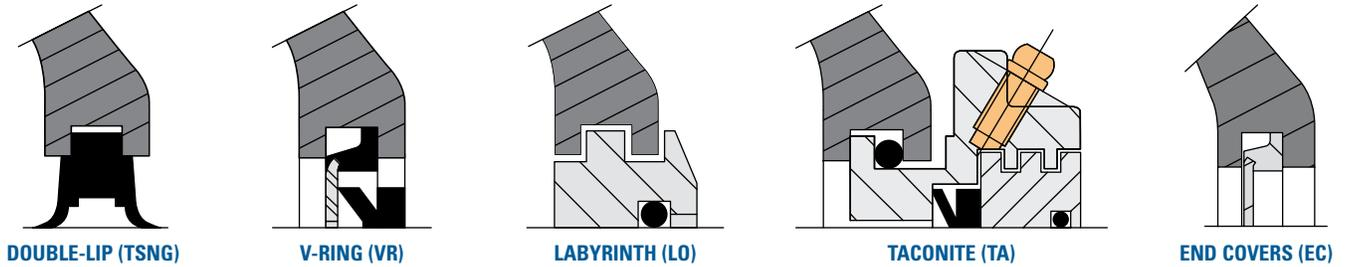

SEAL OPTIONS: 3000 AND 3100 SERIES

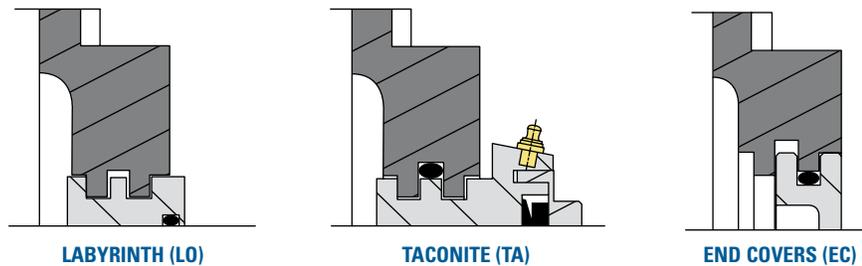

SEAL DESCRIPTIONS

Timken® SNT split plummer blocks are available with multiple sealing options. Each seal type incorporates specific features to meet your application needs. The table on the following page compares the various features of each seal type.

DOUBLE-LIP SEALS (TSNG)

Double-lip seals are the most common seal design used with SNT split plummer blocks. These are general all-purpose elastomer seals that can protect in moderately contaminated environments. The seal is split into two 180 degree halves for easy installation. The seal element runs against the shaft surface and should be used in grease lubricated blocks. Contact your Timken engineer for double-lip seal availability when using cylindrical bore housings.

V-RING SEALS (VR)

V-ring seals are a deflector type seal. They are made up of an elastomer V-ring seal element that rotates with the shaft and runs against the axial surface of a washer-type component that is retained in the block housing. As the V-ring element is a stretch fit onto the shaft, a rougher shaft surface is acceptable. This seal performs well in moderately contaminated environments with fine particulate.

LABYRINTH SEALS (LO)

Labyrinth seals are made up of a single metal ring component that interconnects with the grooves in the housing to form a labyrinth gap. The inside diameter of the metal ring contains an O-ring that creates an interference fit with the shaft so that the ring will rotate with the shaft. Labyrinth seals can be used on high-speed applications and in moderately contaminated environments.

TACONITE SEALS (TA)

Taconite seals are a combination of both a labyrinth seal and V-ring seal. The labyrinth seal is made up of two separate metal ring components, inner and outer, that have interconnecting grooves that form a labyrinth gap. The outer metal ring component contains an O-ring on its outside diameter that provides an interference fit to the groove in the housing. The inside diameter of the inner metal ring component contains an O-ring that creates an interference fit with the shaft so that the ring will rotate with the shaft. This seal performs well in highly contaminated environments such as those seen in mining operations.

END COVERS (EC)

In some applications, the shaft end is designed to terminate inside the pillow block. For this design, positive fitting end-cover inserts are available to help seal out contaminants and retain lubricants – providing additional protection to the bearing.

SEAL SELECTION

Seal Selection	Double-Lip (TSNG)	V-Ring (VR)	Labyrinth (LO)	Taconite (TA)
Material	NBR	NBR rubber + mild steel plate	Steel + NBR O-ring	Steel + NBR O-ring and V-ring
Temperature	-40° to 100° C (-40° to 212° F)	-40° to 100° C (-40° to 212° F)	-40° to 120° C (-40° to 248° F)	-40° to 100° C (-40° to 212° F)
Maximum linear speed	8 m/s (26 f/s)	7 m/s (23 f/s)	Same as bearing	7 m/s (23 f/s)
Grease relubrication ⁽¹⁾	Excellent	Excellent	Good	Good
Low friction	Good	Good	Excellent	Good
Resists dust/fine particles	Excellent	Excellent	Good	Excellent
Resists coarse particles	Good	Fair	Excellent	Good
Resists water	Good	Good	Fair	Good
Misalignment Shaft dia. ≤ 100 mm	1°	1.5°	0.3°	0.3°
Misalignment Shaft dia. > 100 mm	0.5°	1°	0.3°	0.3°

⁽¹⁾If an application requires oil lubrication, please contact your Timken engineer.

FLEXIBLE CONFIGURATIONS

With many options to choose from, there's a Timken SNT split plummer block to meet all your needs. Depending on the accessories you choose, a single housing can be used with multiple bearings, in fixed or float positions, and open or closed end covers. Flexible configurations deliver the single solution to meet all of your needs.

Note: A special coating system is also available for marine applications and other highly corrosive environments. Simply add suffix "/127" to the housing part number when ordering.

TAPERED BORE BEARING EXAMPLE: SNT 512-610

BEARING: 21310K
LOCATING RINGS: SR110X10.5
SLEEVE: H310

SEAL OPTIONS
DOUBLE-LIP: TSNG610
LOR: LO610
V-RING: VR610
TACONITE: TA610
END COVER: EC512-610

BEARING: 22310K
LOCATING RINGS: SR110X4
SLEEVE: H2310

SEAL OPTIONS
DOUBLE-LIP: TSNG610
LOR: LO610
V-RING: VR610
TACONITE: TA610
END COVER: EC512-610

BEARING: 22212K
LOCATING RINGS: SR110X10
SLEEVE: H312

SEAL OPTIONS
DOUBLE-LIP: TSNG512
LOR: LO512
V-RING: VR512
TACONITE: TA512
END COVER: EC512-610



SNT NOMENCLATURE: 200–300 AND 500–600 SERIES

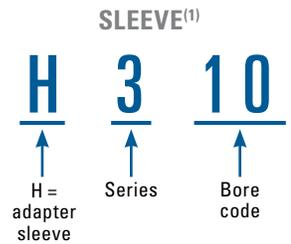
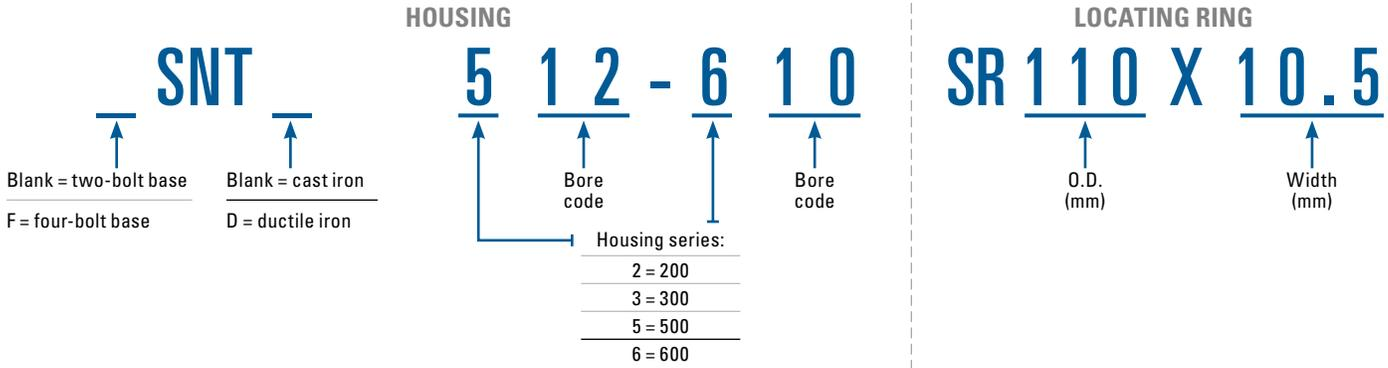

⁽¹⁾Adapter sleeve includes locknut and lockwasher/lock plate

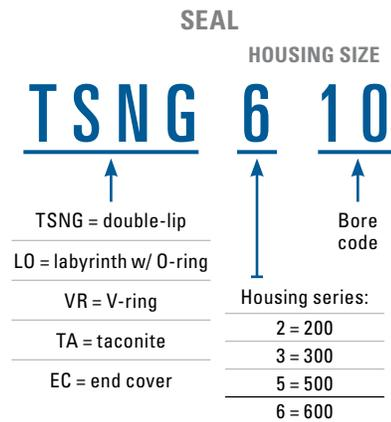

SNT NOMENCLATURE: 3000 AND 3100 SERIES

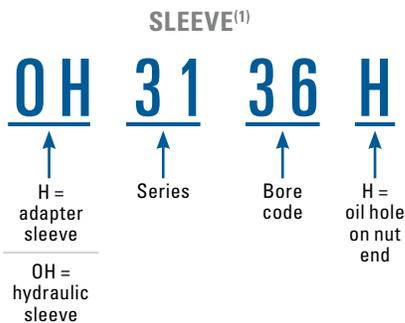
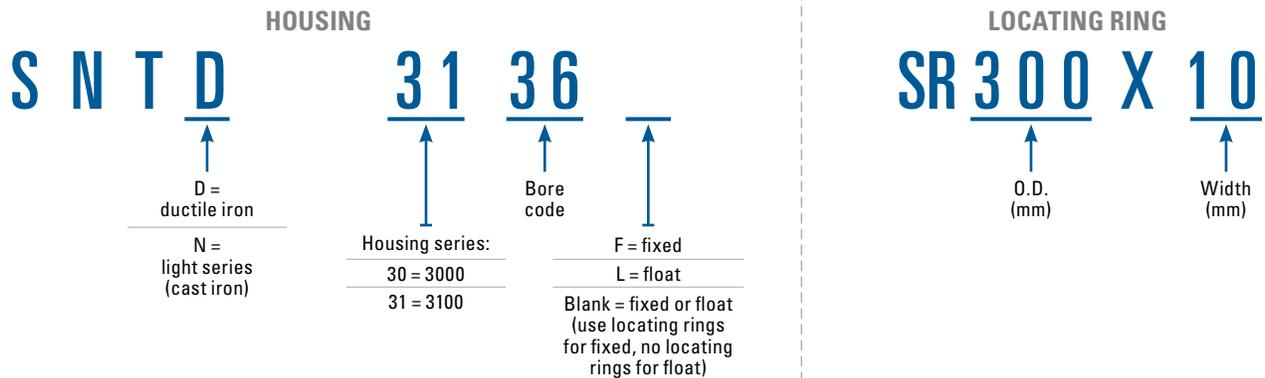

⁽¹⁾Adapter sleeve includes locknut and lockwasher/lock plate

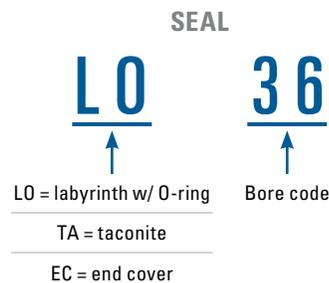

TAPERED BORE BEARING ASSEMBLY

Typically, spherical roller bearings with tapered bore bearings are selected to simplify shaft mounting and dismounting. Mounting can be simplified by use of an adapter sleeve with a cylindrical bore and tapered O.D. Bearings with a tapered bore typically require a tighter fit on the shaft than bearings with a cylindrical bore. A locknut is typically used to drive the inner ring up a

tapered shaft sleeve. The locknut position is then secured by use of a lockwasher or lockplate. For shaft sizes above 200 mm, hydraulic sleeves are offered to ease disassembly. Timken offers a wide range of accessories for the assembly housed units with tapered bore spherical roller bearings (see Timken Spherical Roller Bearing Catalog Or. 10446).



TIMKEN® HIGH-PERFORMANCE ROLLER HOUSED UNIT GREASE

Experience the difference of a grease engineered specifically for roller housed units: Timken® high-performance roller housed unit grease (Timken GR255). It's ideal for industrial applications with extreme loads, high wear, moderate speeds, high temperatures and shock loading.

Compatible with most industrial materials and able to operate within a wide temperature range, our high-performance roller housed unit grease is one more answer from Timken for efficient, reliable operations in tough environments.



HOUSING STRENGTH

Timken SNT housed units are intended to be mounted with the base fully supported and loads applied directly into the base. Housing strength may become the limiting factor in applications where load is not applied directly into the base or if the base is unsupported. In those cases, housing safe loads should be considered.

Safe load guidelines for Timken SNT housings where load is not applied directly into the base or if the base is unsupported (P0) are shown in the tables below. The safe load guidelines have taken into account the breaking strength of the housing,

the breaking strength of the cap bolts, and include appropriate safety factors. Safety factors are aligned with accepted engineering practices for the housing material and cap bolts. Additional safety factors may be applied by the user for safety critical applications. The published safe load values assume the housing has been properly secured to the base structure and proper torque has been applied to the cap bolts.

Contact your Timken engineering or sales representative for any questions on housing strength or to discuss high-risk applications.

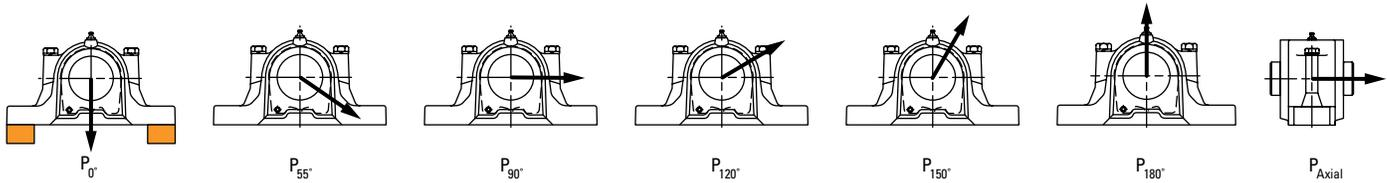

SAFE LOAD 500/600 AND 200/300 SERIES - 2 AND 4 BOLT GRAY CAST IRON

Housing	SAFE LOAD						
	Load Direction						
	0°	55°	90°	120°	150°	180°	Axial
	kN	kN	kN	kN	kN	kN	kN
SNT 205, SNT 505	10	22	18	7	9	11	9
SNT 206-305, SNT 506-605	15	29	18	10	10	12	10
SNT 207, SNT 507-606	20	36	18	13	12	14	11
SNT 208-307, SNT 508-607	26	44	19	16	14	15	12
SNT 209, SNT 509	32	52	21	20	15	17	13
SNT 210, SNT 510-608	37	60	23	23	18	19	15
SNT 211, (F)SNT 511-609	44	69	25	26	20	22	16
SNT 212, (F)SNT 512-610	50	78	28	29	23	24	18
SNT 213, (F)SNT 513-611	57	87	32	33	25	27	19
SNT 215, (F)SNT 515-612	64	97	36	36	28	30	21
SNT 216, (F)SNT 516-613	71	107	41	39	32	33	23
SNT 217, (F)SNT 517	78	118	46	43	35	36	25
SNT 218, (F)SNT 518-615	86	128	52	46	39	40	27
(F)SNT 519-616	94	139	59	50	43	44	30
(F)SNT 520-617	102	151	66	54	47	48	32
(F)SNT 522-619	120	175	81	61	56	57	37
(F)SNT 524-620	138	201	99	68	66	67	43
(F)SNT 526	148	214	109	72	71	72	46
(F)SNT 528	167	242	130	80	82	83	52
(F)SNT 530	188	271	153	88	94	95	58
(F)SNT 532	199	286	166	92	101	102	62

Note: Safe Load (kN), ASTM A48, grade 30 cast iron housings; class 8.8 cap bolts.

SAFE LOAD 500/600 AND 200/300 SERIES - 2 AND 4 BOLT DUCTILE IRON

Housing	SAFE LOAD						
	Load Direction						
	0°	55°	90°	120°	150°	180°	Axial
	kN	kN	kN	kN	kN	kN	kN
SNTD 205, SNTD 505	32	33	34	42	43	45	29
SNTD 206-305, SNTD 506-605	39	44	36	39	45	45	30
SNTD 207, SNTD 507-606	47	56	40	37	47	46	30
SNTD 208-307, SNTD 508-607	56	69	44	37	50	48	32
SNTD 209, SNTD 509	66	83	49	37	53	50	33
SNTD 210, SNTD 510-608	76	98	55	39	57	53	35
SNTD 211, (F)SNTD 511-609	87	115	61	42	62	57	38
SNTD 212, (F)SNTD 512-610	99	132	69	46	67	61	40
SNTD 213, (F)SNTD 513-611	112	150	77	51	72	66	44
SNTD 215, (F)SNTD 515-612	126	170	85	58	79	72	47
SNTD 216, (F)SNTD 516-613	140	190	95	66	86	78	52
SNTD 217, (F)SNTD 517	156	212	105	74	93	85	56
SNTD 218, (F)SNTD 518-615	172	234	116	85	101	92	61
(F)SNTD 519-616	189	258	127	96	110	101	67
(F)SNTD 520-617	206	282	139	108	119	110	72
(F)SNTD 522-619	244	335	166	137	139	129	85
(F)SNTD 524-620	285	391	196	170	162	152	100
(F)SNTD 526	306	421	212	188	174	164	108
(F)SNTD 528	352	484	246	229	201	190	125
(F)SNTD 530	401	550	283	274	229	219	144
(F)SNTD 532	427	585	302	298	245	234	154

Note: Safe Load (kN), ASTM A536, grade 65-45-12 ductile iron housings; class 10.9 cap bolts.

**SAFE LOAD
3000 SERIES
DUCTILE IRON**

SAFE LOAD							
Housing	Load Direction						
	0°	55°	90°	120°	150°	180°	Axial
	kN	kN	kN	kN	kN	kN	kN
SNTD 3036	499	798	434	355	442	451	262
SNTD 3038	693	905	490	431	464	471	323
SNTD 3040	787	961	520	467	477	483	353
SNTD 3044	967	1080	580	537	507	511	413
SNTD 3048	1137	1206	643	603	541	544	471
SNTD 3052	1298	1341	708	665	580	582	528
SNTD 3056	1450	1482	776	722	623	625	583
SNTD 3060	1592	1632	845	776	671	673	638
SNTD 3064	1725	1790	918	825	724	726	691
SNTD 3068	1848	1955	992	870	781	784	743
SNTD 3072	1962	2128	1069	911	843	847	794
SNTD 3076	2067	2309	1148	949	910	916	843
SNTD 3080	2162	2497	1230	981	981	989	892
SNTD 3084	2247	2693	1314	1010	1057	1067	939
SNTD 3088	2287	2795	1357	1023	1097	1108	962
SNTD 3092	2358	3002	1444	1046	1179	1193	1007
SNTD 3096	2420	3218	1534	1064	1267	1284	1051
SNTD 30/500	2473	3442	1626	1079	1359	1380	1094
SNTD 30/530	2534	3791	1769	1093	1506	1533	1156

Note: Safe Load (kN), ASTM A536, grade 65-45-12 ductile iron housings; class 10.9 cap bolts.

**SAFE LOAD
3100 SERIES
DUCTILE IRON**

SAFE LOAD							
Housing	Load direction						
	0°	55°	90°	120°	150°	180°	Axial
	kN	kN	kN	kN	kN	kN	kN
SNTD 3134	437	563	395	339	466	468	311
SNTD 3136	521	630	421	360	474	475	310
SNTD 3138	606	701	449	383	484	485	310
SNTD 3140	691	777	478	407	496	496	314
SNTD 3144	862	939	542	460	527	526	328
SNTD 3148	1033	1117	614	518	567	564	352
SNTD 3152	1205	1311	692	581	614	611	386
SNTD 3156	1377	1521	778	651	671	666	430
SNTD 3160	1549	1747	871	725	735	730	484
SNTD 3164	1722	1989	971	805	808	802	548
SNTD 3168	1896	2247	1079	891	890	883	622
SNTD 3172	2070	2521	1193	982	980	973	706
SNTD 3176	2245	2810	1315	1079	1079	1070	800
SNTD 3180	2420	3116	1443	1181	1186	1177	904
SNTD 3184	2596	3437	1579	1288	1301	1291	1018
SNTD 3188	2684	3604	1650	1344	1362	1352	1079
SNTD 3192	2861	3949	1797	1460	1490	1480	1208
SNTD 3196	3038	4310	1951	1581	1626	1616	1347

Note: Safe Load (kN), ASTM A536, grade 65-45-12 ductile iron housings; class 10.9 cap bolts.

RADIAL INTERNAL CLEARANCE

RADIAL INTERNAL CLEARANCE CALCULATING RIC REDUCTION USING A SPHERICAL ROLLER BEARING WITH TAPERED BORE

Given bearing number 22328K C3 (140 mm bore with C3 clearance) is to be mounted on a tapered shaft. Using a set of feeler gages, RIC is measured at:

$$RIC = 0.178 \text{ mm}$$

Suggested reduction of RIC due to installation =
0.064 mm – 0.089 mm, found in the RIC table for tapered bore.

Calculate the clearance after mounting:

$$0.178 \text{ mm} - 0.076 \text{ mm} = 0.102 \text{ mm}$$

For this example, the value of 0.076 mm was obtained by taking the mid-range value of the upper and lower limits found in the table on the next page.

Therefore, the locknut should be tightened until RIC reaches 0.102 mm.



Measure RIC before installation.



After mounting, the RIC should be checked at the unloaded roller.

It also should be noted that the value obtained by reading the suggested RIC after installation directly from the table is 0.056 mm.

This differs from the value calculated in the example. The value taken directly from the table is provided as a minimum value. It is not suggested to use a calculated value that falls below this minimum.

RADIAL INTERNAL CLEARANCE (CONTINUED)

MOUNTING TAPERED BORE SPHERICAL ROLLER BEARINGS

- Use a feeler gage with the thinnest blade of 0.038 mm.
- Place the bearing in an upright position with the inner and outer rings facing parallel.
- Place thumbs on the inner ring bore and oscillate the inner ring the distance of two or three roller spacings.
- Position the individual roller assemblies so that a roller is at the top of the inner ring on both sides of the bearing.
- With the roller in the correct position, insert a thin blade of the feeler gage between the roller and the outer ring.
- Move the feeler gage carefully along the top roller between the roller and outer ring raceway. Repeat this procedure using thicker feeler gage blades until one is found that will not go through.
- The blade thickness that preceded the no-go blade is a measure of RIC before installation.
- Start the mounting procedure by lubricating the tapered shaft with a light coat of machine oil.
- Slide the bearing onto the shaft as far as it will go by hand.
- As the locknut is tightened, the interference fit builds up, resulting in expansion of the inner ring.
- Periodically measure to monitor the reduction in RIC.
- Continue the procedure until the proper amount of reduction is obtained. Do not exceed calculated amount of reduction.
- As a final check, make sure the remaining RIC equals or exceeds the minimum mounted clearance shown in the table below.
- During mounting, the RIC should be checked at the unloaded roller. If this is at the bottom, make sure that the roller is raised to seat firmly at the inboard position of the inner ring.
- When the suggested amount of RIC reduction has been accomplished, the bearing is properly fitted.
- Complete the procedure by peening the lockwasher tang into the locknut slot or securing the lockplate.

For more information about spherical roller bearings please refer to SRB catalog Or. 10446.

RADIAL INTERNAL CLEARANCE LIMITS – SPHERICAL ROLLER BEARINGS USED IN SNT HOUSINGS TAPERED BORE

Bore (Nominal)		Normal CO				C4		Suggested Reduction of RIC due to Installation	Axial Displacement of Inner Ring for RIC Reduction – SNT Tapered Sleeve Mounting ⁽¹⁾		Minimum Permissible RIC after Installation ⁽¹⁾		
		Min.	Max.	Min.	Max.	Min.	Max.		1:12 Taper		CO	C3	C4
Over	Incl.								Min.	Max.			
20	30	30	40	55	75	15	20	253	330	15	25	40	
30	40	35	50	65	85	20	25	330	418	15	25	40	
40	50	45	60	80	100	25	30	418	506	20	30	50	
50	65	55	75	95	120	30	38	506	616	25	40	60	
65	80	70	95	120	150	38	51	616	836	25	45	75	
80	100	80	110	140	180	46	64	748	1067	36	50	75	
100	120	100	135	170	220	51	71	836	1177	51	60	100	
120	140	120	160	200	260	64	89	979	1397	56	75	115	
140	160	130	180	230	300	76	102	1254	1672	56	75	125	
160	180	140	200	260	340	76	114	1254	1815	61	90	150	
180	200	160	220	290	370	89	127	1540	2090	71	100	165	
200	225	180	250	320	410	102	140	1672	2233	76	115	180	
225	250	200	270	350	450	114	152	1958	2519	89	115	200	
250	280	220	300	390	490	114	165	1958	2794	102	140	230	
280	315	240	330	430	540	127	178	2090	2937	102	150	250	
315	355	270	360	470	590	140	190	2233	3069	114	165	280	
355	400	300	400	520	650	152	203	2519	3355	127	190	330	
400	450	330	440	570	720	165	216	2794	3630	152	230	360	
450	500	370	490	630	790	178	229	2937	3773	165	270	410	
500	560	410	540	680	870	203	254	3355	4191	178	290	440	

⁽¹⁾This displacement is valid for assembly of tapered bore bearings on solid steel shafts and is measured from a line-to-line fit of the bearing bore to the tapered shaft. For questions on tapered shaft data, consult your Timken engineer.

Note: Tolerance and shaft diameters are shown in the table as variances from nominal bearing bore.

RADIAL INTERNAL CLEARANCE LIMITS – SPHERICAL ROLLER BEARINGS USED IN SNT HOUSINGS CYLINDRICAL BORE

Bore (Nominal)		Normal CO				C4	
		Min.	Max.	Min.	Max.	Min.	Max.
Over	Incl.						
20	30	25	40	55	75		
30	40	30	45	60	80		
40	50	35	55	75	100		
50	65	40	65	90	120		
65	80	50	80	110	145		
80	100	60	100	135	180		
100	120	75	120	160	210		
120	140	95	145	190	240		
140	160	110	170	220	280		
160	180	120	180	240	310		
180	200	130	200	260	340		
200	225	140	220	290	380		
225	250	150	240	320	420		
250	280	170	260	350	460		
280	315	190	280	370	500		
315	355	200	310	410	550		
355	400	220	340	450	600		
400	450	240	370	500	660		
450	500	260	410	550	720		
500	560	280	440	600	780		

SHAFT LENGTH GUIDELINES

SHAFT END CLEARANCE VALUES

The tables below provide the minimum required (S1) and maximum possible (S2) shaft lengths for cases where the shaft ending is inside the housing. The values provide guidance for shaft design, but may not take into account

all application conditions like float and axial expansion. The minimum and maximum shaft length values are dimensioned from the center of the housing. Please contact your Timken representative if any special requirements are needed.

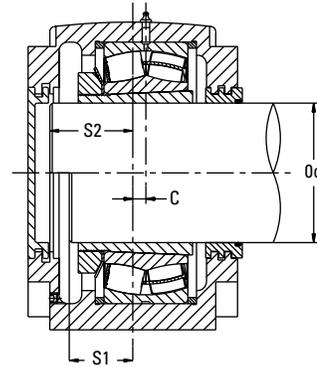
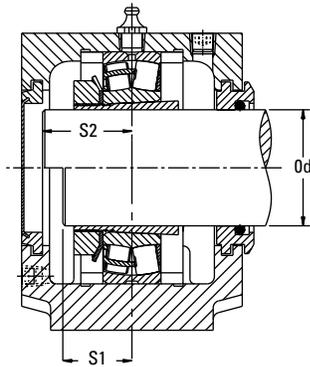

MINIMUM AND MAXIMUM SHAFT LENGTHS 500/600 AND 200/300 SERIES – 2 AND 4 BOLT

Housing	S1	S2
	mm	mm
SNT 205, SNT 505	18	23
SNT 206-305, SNT 506-605	19	29
SNT 207, SNT 507-606	22	30
SNT 208-307, SNT 508-607	23	32
SNT 209, SNT 509	24	31
SNT 210, SNT 510-608	28	34
SNT 211, (F)SNT 511-609	30	36
SNT 212, (F)SNT 512-610	33	41
SNT 213, (F)SNT 513-611	35	44
SNT 215, (F)SNT 515-612	37	46
SNT 216, (F)SNT 516-613	39	49
SNT 217, (F)SNT 517	37	51
SNT 218, (F)SNT 518-615	45	59
(F)SNT 519-616	47	60
(F)SNT 520-617	51	68
(F)SNT 522-619	57	73
(F)SNT 524-620	61	79
(F)SNT 526	64	82
(F)SNT 528	69	89
(F)SNT 530	75	95
(F)SNT 532	81	104

MINIMUM AND MAXIMUM SHAFT LENGTHS LIGHT SERIES 3000

Housing	S1	S2
	mm	mm
SNTN 3024	46	72
SNTN 3026	50	79
SNTN 3028	52	79
SNTN 3030	55	87
SNTN 3032	59	87
SNTN 3034	63	92

MINIMUM AND MAXIMUM SHAFT LENGTHS 3000 SERIES

Housing	S1	S2
	mm	mm
SNTD 3036	54	84
SNTD 3038	66	89
SNTD 3040	63	98
SNTD 3044	66	108
SNTD 3048	78	113
SNTD 3052	75	122
SNTD 3056	89	129
SNTD 3060	86	129
SNTD 3064	83	144
SNTD 3068	90	154
SNTD 3072	90	153
SNTD 3076F	93	169
SNTD 3076L	93	169
SNTD 3080F	97	169
SNTD 3080L	97	169
SNTD 3084F	98	169
SNTD 3084L	98	169
SNTD 3088F	110	184
SNTD 3088L	110	184
SNTD 3092F	108	199
SNTD 3092L	108	199
SNTD 3096F	109	199
SNTD 3096L	109	199
SNTD 30/500F	118	199
SNTD 30/500L	118	199
SNTD 30/530F	127	199
SNTD 30/530L	127	199

MINIMUM AND MAXIMUM SHAFT LENGTHS 3100 SERIES

Housing	S1	S2
	mm	mm
SNTD 3134	57	84
SNTD 3136	61	89
SNTD 3138	71	98
SNTD 3140	79	108
SNTD 3144	84	113
SNTD 3148	86	122
SNTD 3152	99	129
SNTD 3156	99	129
SNTD 3160	99	144
SNTD 3164	108	154
SNTD 3168F	126	169
SNTD 3168L	126	169
SNTD 3172F	125	169
SNTD 3172L	125	169
SNTD 3176F	128	169
SNTD 3176L	128	169
SNTD 3180F	133	184
SNTD 3180L	133	184
SNTD 3184F	148	199
SNTD 3184L	148	199
SNTD 3188F	149	199
SNTD 3188L	149	199
SNTD 3192F	161	204
SNTD 3192L	161	204
SNTD 3196F	165	204
SNTD 3196L	165	204

TWO-BOLT SNT HOUSINGS FOR TAPERED BORE BEARINGS

- The part numbers for ordering split plummer block housings and components are listed in the table below.
- Each housing includes the housing cap, housing base and cap bolts.
- Specify bearing suffix W33 for center lubrication of groove and holes, and use the housing center port for the grease fitting.

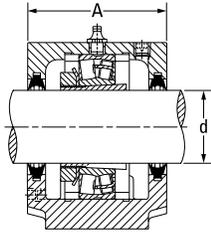

Double-Lip Seal

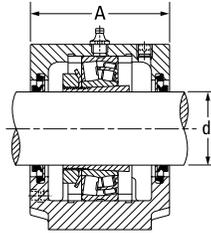

V-Ring Seal

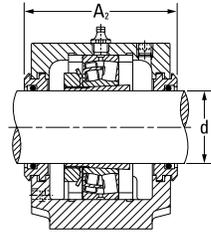

Labyrinth Seal

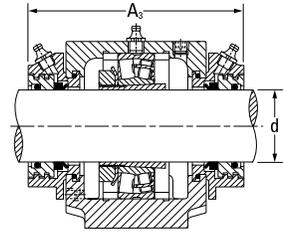

Tacanite Seal

Shaft Dia.	Housing	Bearing	Locating Rings ⁽¹⁾	Adapter Sleeve ⁽²⁾	Double-Lip Seal ⁽³⁾	V-Ring Seal ⁽³⁾	Labyrinth Seal ⁽⁴⁾	Tacanite Seal ⁽⁴⁾	End Cover ⁽⁴⁾
d			O.D. x Width						
mm									
20	SNT 505	22205K	SR52X3.5	H305	TSNG505	VR505	L0505	TA505	EC505
	SNT 506-605	21305K	SR62X7.5	H305	TSNG605	VR605	L0605	TA605	EC506-605
25	SNT 506-605	22206K	SR62X6	H306	TSNG506	VR506	L0506	TA506	EC506-605
	SNT 507-606	21306K	SR72X7.5	H306	TSNG606	VR606	L0606	TA606	EC507-606
30	SNT 507-606	22207K	SR72X5.5	H307	TSNG507-305	VR507	L0507	TA507	EC507-606
	SNT 508-607	21307K	SR80X9	H307	TSNG607	VR607	L0607	TA607	EC508-607
35	SNT 508-607	22208K	SR80X8	H308	TSNG508	VR508	L0508	TA508	EC508-607
	SNT 510-608	21308K	SR90X9	H308	TSNG608	VR608	L0608	TA608	EC510-608
	SNT 510-608	22308K	SR90X4	H2308	TSNG608	VR608	L0608	TA608	EC510-608
40	SNT 509	22209K	SR85X3.5	H309	TSNG509	VR509	L0509	TA509	EC509
	SNT 511-609	21309K	SR100X9.5	H309	TSNG609	VR609	L0609	TA609	EC511-609
	SNT 511-609	22309K	SR100X4	H2309	TSNG609	VR609	L0609	TA609	EC511-609
45	SNT 510-608	22210K	SR90X9	H310	TSNG510-307	VR510	L0510	TA510	EC510-608
	SNT 512-610	21310K	SR110X10.5	H310	TSNG610	VR610	L0610	TA610	EC512-610
	SNT 512-610	22310K	SR110X4	H2310	TSNG610	VR610	L0610	TA610	EC512-610
50	SNT 511-609	22211K	SR100X9.5	H311	TSNG511	VR511	L0511	TA511	EC511-609
	SNT 513-611	21311K	SR120X11	H311	TSNG611	VR611	L0611	TA611	EC513-611
	SNT 513-611	22311K	SR120X4	H2311	TSNG611	VR611	L0611	TA611	EC513-611
55	SNT 512-610	22212K	SR110X10	H312	TSNG512	VR512	L0512	TA512	EC512-610
	SNT 515-612	21312K	SR130X12.5	H312	TSNG612	VR612	L0612	TA612	EC515-612
	SNT 515-612	22312K	SR130X5	H2312	TSNG612	VR612	L0612	TA612	EC515-612
60	SNT 513-611	22213K	SR120X10	H313	TSNG513	VR513	L0513	TA513	EC513-611
	SNT 516-613	21313K	SR140X12.5	H313	TSNG613	VR613	L0613	TA613	EC516-613
	SNT 516-613	22313K	SR140X5	H2313	TSNG613	VR613	L0613	TA613	EC516-613

⁽¹⁾Locating rings = two required for fixed position, sold one piece per box.
⁽²⁾Adapter sleeve assembly includes one sleeve, one locknut and one lockwasher.
⁽³⁾Double-lip and V-ring seals sold two seals per box.
⁽⁴⁾Labyrinth, tacanite seal and end cover sold one seal per box.

3D CAD and 2D drawings available at <http://cad.timken.com/category/snt-housed-units>

500/600 SERIES

- Grease hole fittings and plugs use 1/8 BSPT thread size for all housings up to 520-617. Housings 522-619 and larger use 1/4 BSPT thread size.
- Housings shown are furnished in cast iron. If ductile iron is desired, add the letter D to the alpha prefix (e.g., SNTD 505).

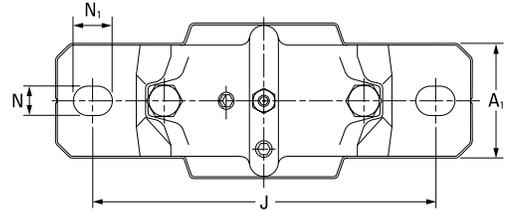
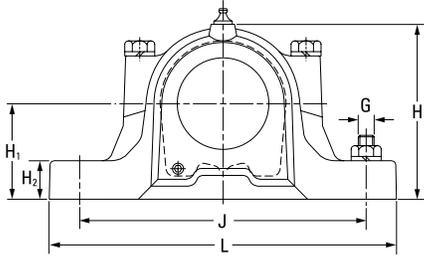

Housing Dimensions											2 Bolts Req'd	Housing Mass
A	A ₁	A ₂	A ₃	H	H ₁	H ₂	J	L	N	N ₁	G	
mm	mm	mm	mm	mm	mm	mm	mm	mm	mm	mm	mm	kg
67	46	80	130	74	40	19	130	165	15	20	12	1.5
77	52	89	135	89	50	22	150	185	15	20	12	2.0
77	52	89	135	89	50	22	150	185	15	20	12	2.0
82	52	94	140	93	50	22	150	185	15	20	12	2.2
85	60	97	145	108	60	25	170	205	15	20	12	2.9
85	60	97	145	108	60	25	170	205	15	20	12	2.9
90	60	102	150	113	60	25	170	205	15	20	12	3.2
90	60	102	150	113	60	25	170	205	15	20	12	3.2
85	60	97	150	109	60	25	170	205	15	20	12	2.9
95	70	107	155	128	70	28	210	255	18	24	16	4.5
95	70	107	155	128	70	28	210	255	18	24	16	4.5
90	60	102	150	113	60	25	170	205	15	20	12	3.2
105	70	117	165	134	70	30	210	255	18	24	16	5.3
105	70	117	165	134	70	30	210	255	18	24	16	5.3
95	70	107	155	128	70	28	210	255	18	24	16	4.5
110	80	122	170	150	80	30	230	275	18	24	16	6.6
110	80	122	170	150	80	30	230	275	18	24	16	6.6
105	70	117	165	134	70	30	210	255	18	24	16	5.3
115	80	127	175	156	80	30	230	280	18	24	16	6.9
115	80	127	175	156	80	30	230	280	18	24	16	6.9
110	80	122	170	150	80	30	230	275	18	24	16	6.6
120	90	138	180	177	95	32	260	315	22	28	20	9.7
120	90	138	180	177	95	32	260	315	22	28	20	9.7

Continued on next page.

TWO-BOLT SNT HOUSINGS FOR TAPERED BORE BEARINGS

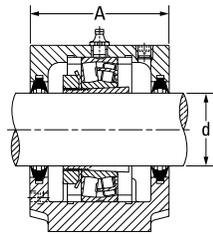

Double-Lip Seal

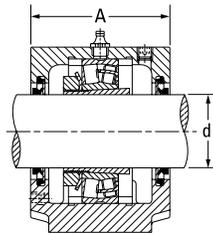

V-Ring Seal

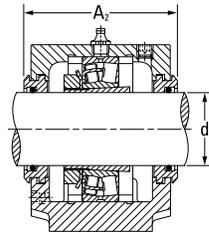

Labyrinth Seal

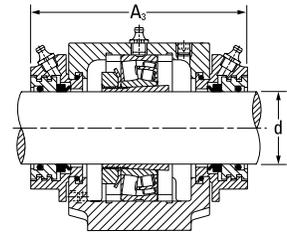

Taconite Seal

Continued from previous page.

Shaft Dia.	Housing	Bearing	Locating Rings ⁽¹⁾	Adapter Sleeve ⁽²⁾	Double-Lip Seal ⁽³⁾	V-Ring Seal ⁽³⁾	Labyrinth Seal ⁽⁴⁾	Taconite Seal ⁽⁴⁾	End Cover ⁽⁴⁾
d			O.D. x Width						
mm									
65	SNT 515-612	22215K	SR130X12.5	H315	TSNG515	VR515	L0515	TA515	EC515-612
	SNT 518-615	21315K	SR160X14	H315	TSNG615	VR615	L0615	TA615	EC518-615
	SNT 518-615	22315K	SR160X5	H2315	TSNG615	VR615	L0615	TA615	EC518-615
70	SNT 516-613	22216K	SR140X12.5	H316	TSNG516	VR516	L0516	TA516	EC516-613
	SNT 519-616	21316K	SR170X14.5	H316	TSNG616	VR616	L0616	TA616	EC519-616
	SNT 519-616	22316K	SR170X5	H2316	TSNG616	VR616	L0616	TA616	EC519-616
75	SNT 517	22217K	SR150X12.5	H317	TSNG517	VR517	L0517	TA517	EC517
	SNT 520-617	21317K	SR180X14.5	H317	TSNG617	VR617	L0617	TA617	EC520-617
	SNT 520-617	22317K	SR180X5	H2317	TSNG617	VR617	L0617	TA617	EC520-617
80	SNT 518-615	22218K	SR160X12.5	H318	TSNG518	VR518	L0518	TA518	EC518-615
	SNT 518-615	23218K	SR160X6.25	H2318	TSNG518	VR518	L0518	TA518	EC518-615
85	SNT 519-616	22219K	SR170X12.5	H319	TSNG519	VR519	L0519	TA519	EC519-616
	SNT 522-619	21319K	SR200X17.5	H319	TSNG619	VR619	L0619	TA619	EC522-619
	SNT 522-619	22319K	SR200X6.5	H2319	TSNG619	VR619	L0619	TA619	EC522-619
90	SNT 520-617	22220K	SR180X12	H320	TSNG520	VR520	L0520	TA520	EC520-617
	SNT 520-617	23220K	SR180X4.85	H2320	TSNG520	VR520	L0520	TA520	EC520-617
	SNT 524-620	21320K	SR215X19.5	H320	TSNG620	VR620	L0620	TA620	EC524-620
	SNT 524-620	22320K	SR215X6.5	H2320	TSNG620	VR620	L0620	TA620	EC524-620
100	SNT 522-619	22222K	SR200X13.5	H322	TSNG522	VR522	L0522	TA522	EC522-619
	SNT 522-619	23222K	SR200X5.1	H2322	TSNG522	VR522	L0522	TA522	EC522-619
110	SNT 524-620	22224K	SR215X14	H3124	TSNG524	VR524	L0524	TA524	EC524-620
	SNT 524-620	23224K	SR215X5	H2324	TSNG524	VR524	L0524	TA524	EC524-620
115	SNT 526	22226K	SR230X13	H3126	TSNG526	VR526	L0526	TA526	EC526
	SNT 526	23226K	SR230X5	H2326	TSNG526	VR526	L0526	TA526	EC526
125	SNT 528	22228K	SR250X15	H3128	TSNG528	VR528	L0528	TA528	EC528
	SNT 528	23228K	SR250X5	H2328	TSNG528	VR528	L0528	TA528	EC528
135	SNT 530	22230K	SR270X16.5	H3130	TSNG530	VR530	L0530	TA530	EC530
	SNT 530	23230K	SR270X5	H2330	TSNG530	VR530	L0530	TA530	EC530
140	SNT 532	22232K	SR290X17	H3132	TSNG532	VR532	L0532	TA532	EC532
	SNT 532	23232K	SR290X5	H2332	TSNG532	VR532	L0532	TA532	EC532

⁽¹⁾ Locating rings = two required for fixed position, sold one piece per box.

⁽²⁾ Adapter sleeve assembly includes one sleeve, one locknut and one lockwasher.

⁽³⁾ Double-lip and V-ring seals sold two seals per box.

⁽⁴⁾ Labyrinth, taconite seal and end cover sold one seal per box.

3D CAD and 2D drawings available at <http://cad.timken.com/category/snt-housed-units>

500/600 SERIES (CONTINUED)

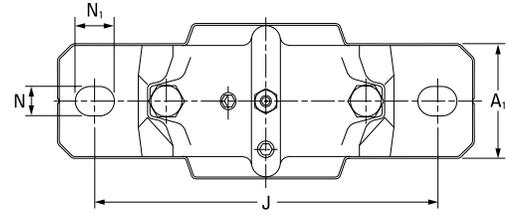
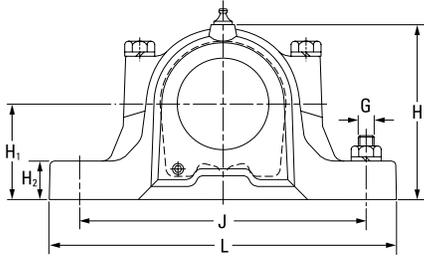

Housing Dimensions											2 Bolts Req'd	Housing Mass
A	A ₁	A ₂	A ₃	H	H ₁	H ₂	J	L	N	N ₁	G	
mm	mm	mm	mm	mm	mm	mm	mm	mm	mm	mm	mm	kg
115	80	127	175	156	80	30	230	280	18	24	16	6.9
140	100	158	225	194	100	35	290	345	22	28	20	13.1
140	100	158	225	194	100	35	290	345	22	28	20	13.1
120	90	138	180	177	95	32	260	315	22	28	20	9.7
145	100	163	220	212	112	35	290	345	22	28	20	14.0
145	100	163	220	212	112	35	290	345	22	28	20	14.0
125	90	143	210	183	95	32	260	320	22	28	20	10.4
160	110	178	235	218	112	40	320	380	26	32	24	17.6
160	110	178	235	218	112	40	320	380	26	32	24	17.6
140	100	158	225	194	100	35	290	345	22	28	20	13.1
140	100	158	225	194	100	35	290	345	22	28	20	13.1
145	100	163	220	212	112	35	290	345	22	28	20	14.0
175	120	191	250	242	125	45	344	410	32	26	24	22.3
175	120	191	250	242	125	45	350	410	26	32	24	22.3
160	110	178	235	218	112	40	320	380	26	32	24	17.6
160	110	178	235	218	112	40	320	380	26	32	24	17.6
185	120	199	260	271	140	45	350	410	26	32	24	26.5
185	120	199	260	271	140	45	350	410	26	32	24	26.5
175	120	191	250	242	125	45	350	410	26	32	24	22.3
175	120	191	250	242	125	45	350	410	26	32	24	22.3
185	120	199	260	271	140	45	350	410	26	32	24	26.5
185	120	199	260	271	140	45	350	410	26	32	24	26.5
190	130	208	265	290	150	50	380	445	28	35	24	34.0
190	130	208	265	290	150	50	380	445	28	35	24	34.0
205	150	223	285	302	150	50	420	500	35	42	30	39.0
205	150	223	285	302	150	50	420	500	35	42	30	39.0
220	160	241	295	323	160	60	450	530	35	42	30	48.0
220	160	241	295	323	160	60	450	530	35	42	30	48.0
235	160	254	315	344	170	60	470	550	35	42	30	54.5
235	160	254	315	344	170	60	470	550	35	42	30	54.5

FOUR-BOLT FSNT HOUSINGS FOR TAPERED BORE BEARINGS

- The part numbers for ordering split plummer block housings and components are listed in the table below.
- Each housing includes the housing cap, housing base and cap bolts.
- Specify bearing suffix W33 for center lubrication of groove and holes, and use the housing center port for the grease fitting.

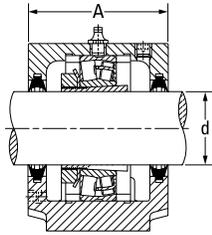

Double-Lip Seal

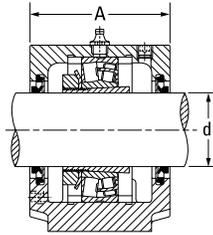

V-Ring Seal

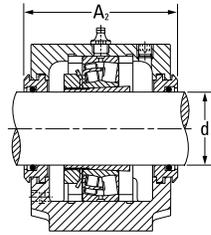

Labyrinth Seal

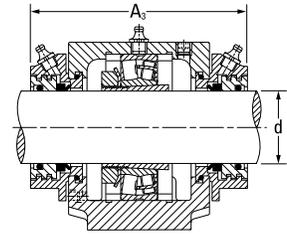

Taconite Seal

Shaft Dia.	Housing	Bearing	Locating Rings ⁽¹⁾	Adapter Sleeve ⁽²⁾	Double-Lip Seal ⁽³⁾	V-Ring Seal ⁽³⁾	Labyrinth Seal ⁽⁴⁾	Taconite Seal ⁽⁴⁾	End Cover ⁽⁴⁾
d			O.D. x Width						
mm									
40	FSNT 511-609	21309K	SR100X9.5	H309	TSNG609	VR609	L0609	TA609	EC511-609
	FSNT 511-609	22309K	SR100X4	H2309	TSNG609	VR609	L0609	TA609	EC511-609
45	FSNT 512-610	21310K	SR110X10.5	H310	TSNG610	VR610	L0610	TA610	EC512-610
	FSNT 512-610	22310K	SR110X4	H2310	TSNG610	VR610	L0610	TA610	EC512-610
50	FSNT 511-609	22211K	SR100X9.5	H311	TSNG511	VR511	L0511	TA511	EC511-609
	FSNT 513-611	21311K	SR120X11	H311	TSNG611	VR611	L0611	TA611	EC513-611
	FSNT 513-611	22311K	SR120X4	H2311	TSNG611	VR611	L0611	TA611	EC513-611
55	FSNT 512-610	22212K	SR110X10	H312	TSNG512	VR512	L0512	TA512	EC512-610
	FSNT 515-612	21312K	SR130X12.5	H312	TSNG612	VR612	L0612	TA612	EC515-612
	FSNT 515-612	22312K	SR130X5	H2312	TSNG612	VR612	L0612	TA612	EC515-612
60	FSNT 513-611	22213K	SR120X10	H313	TSNG513	VR513	L0513	TA513	EC513-611
	FSNT 516-613	21313K	SR140X12.5	H313	TSNG613	VR613	L0613	TA613	EC516-613
	FSNT 516-613	22313K	SR140X5	H2313	TSNG613	VR613	L0613	TA613	EC516-613
65	FSNT 515-612	22215K	SR130X12.5	H315	TSNG515	VR515	L0515	TA515	EC515-612
	FSNT 518-615	21315K	SR160X14	H315	TSNG615	VR615	L0615	TA615	EC518-615
	FSNT 518-615	22315K	SR160X5	H2315	TSNG615	VR615	L0615	TA615	EC518-615
70	FSNT 516-613	22216K	SR140X12.5	H316	TSNG516	VR516	L0516	TA516	EC516-613
	FSNT 519-616	21316K	SR170X14.5	H316	TSNG616	VR616	L0616	TA616	EC519-616
	FSNT 519-616	22316K	SR170X5	H2316	TSNG616	VR616	L0616	TA616	EC519-616
75	FSNT 517	22217K	SR150X12.5	H317	TSNG517	VR517	L0517	TA517	EC517
	FSNT 520-617	21317K	SR180X14.5	H317	TSNG617	VR617	L0617	TA617	EC520-617
	FSNT 520-617	22317K	SR180X5	H2317	TSNG617	VR617	L0617	TA617	EC520-617

⁽¹⁾Locating rings = two required for fixed position, sold one piece per box.

⁽²⁾Adapter sleeve assembly includes one sleeve, one locknut and one lockwasher.

⁽³⁾Double-lip and V-ring seals sold two seals per box.

⁽⁴⁾Labyrinth, taconite seal and end cover sold one seal per box.

3D CAD and 2D drawings available at <http://cad.timken.com/category/snt-housed-units>

500/600 SERIES

- Grease hole fittings and plugs use 1/8 BSPT thread size for all housings up to 520-617. Housings 522-619 and larger use 1/4 BSPT thread size.
- Assemblies shown are furnished in cast iron. If ductile iron is desired, add the letter D to the alpha prefix (e.g., FSNTD 505).

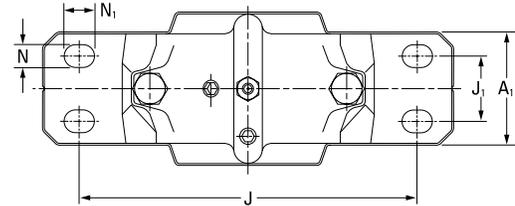
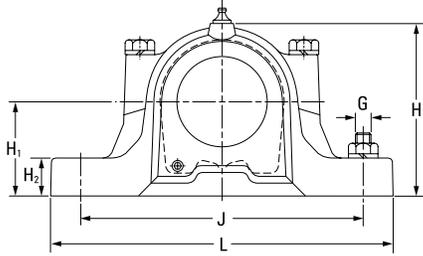

Housing Dimensions												4 Bolts Req'd	Housing Mass
A	A ₁	A ₂	A ₃	H	H ₁	H ₂	J	J ₁	L	N	N ₁	G	
mm	mm	mm	mm	mm	mm	mm	mm	mm	mm	mm	mm	mm	kg
95	70	107	155	128	70	28	210	35	255	15	20	12	4.5
95	70	107	155	128	70	28	210	35	255	15	20	12	4.5
105	70	117	165	134	70	30	210	35	255	15	20	12	5.3
105	70	117	165	134	70	30	210	35	255	15	20	12	5.3
95	70	107	155	128	70	28	210	35	255	15	20	12	4.5
110	80	122	170	150	80	30	230	40	275	15	20	12	6.6
110	80	122	170	150	80	30	230	40	275	15	20	12	6.6
105	70	117	165	134	70	30	210	35	255	15	20	12	5.3
115	80	127	175	156	80	30	230	40	280	15	20	12	6.9
115	80	127	175	156	80	30	230	40	280	15	20	12	6.9
110	80	122	170	150	80	30	230	40	275	15	20	12	6.6
120	90	138	180	177	95	32	260	50	315	18	24	16	9.7
120	90	138	180	177	95	32	260	50	315	18	24	16	9.7
115	80	127	175	156	80	30	230	40	280	15	20	12	6.9
140	100	158	225	194	100	35	290	50	345	18	24	16	13.1
140	100	158	225	194	100	35	290	50	345	18	24	16	13.1
120	90	138	180	177	95	32	260	50	315	18	24	16	9.7
145	100	163	220	212	112	35	290	50	345	18	24	16	14
145	100	163	220	212	112	35	290	50	345	18	24	16	14
125	90	143	210	183	95	32	260	50	320	18	24	16	10.4
160	110	178	235	218	112	40	320	60	380	18	24	16	17.6
160	110	178	235	218	112	40	320	60	380	18	24	16	17.6

Continued on next page.

FOUR-BOLT FSNT HOUSINGS FOR TAPERED BORE BEARINGS

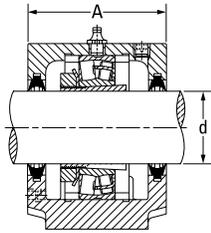

Double-Lip Seal

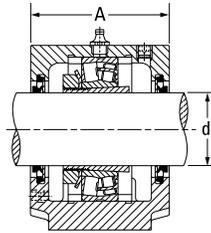

V-Ring Seal

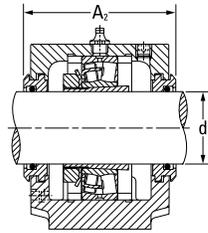

Labyrinth Seal

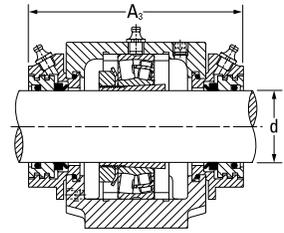

Taconite Seal

Continued from previous page.

Shaft Dia.	Housing	Bearing	Locating Rings ⁽¹⁾	Adapter Sleeve ⁽²⁾	Double-Lip Seal ⁽³⁾	V-Ring Seal ⁽³⁾	Labyrinth Seal ⁽⁴⁾	Taconite Seal ⁽⁴⁾	End Cover ⁽⁴⁾
d			O.D. x Width						
mm									
80	FSNT 518-615	22218K	SR160X12.5	H318	TSNG518	VR518	L0518	TA518	EC518-615
	FSNT 518-615	23218K	SR160X6.25	H2318	TSNG518	VR518	L0518	TA518	EC518-615
85	FSNT 519-616	22219K	SR170X12.5	H319	TSNG519	VR519	L0519	TA519	EC519-616
	FSNT 522-619	21319K	SR200X17.5	H319	TSNG619	VR619	L0619	TA619	EC522-619
	FSNT 522-619	22319K	SR200X6.5	H2319	TSNG619	VR619	L0619	TA619	EC522-619
90	FSNT 520-617	22220K	SR180X12	H320	TSNG520	VR520	L0520	TA520	EC520-617
	FSNT 520-617	23220K	SR180X4.85	H2320	TSNG520	VR520	L0520	TA520	EC520-617
	FSNT 524-620	21320K	SR215X19.5	H320	TSNG620	VR620	L0620	TA620	EC524-620
	FSNT 524-620	22320K	SR215X6.5	H2320	TSNG620	VR620	L0620	TA620	EC524-620
100	FSNT 522-619	22222K	SR200X13.5	H322	TSNG522	VR522	L0522	TA522	EC522-619
	FSNT 522-619	23222K	SR200X5.1	H2322	TSNG522	VR522	L0522	TA522	EC522-619
110	FSNT 524-620	22224K	SR215X14	H3124	TSNG524	VR524	L0524	TA524	EC524-620
	FSNT 524-620	23224K	SR215X5	H2324	TSNG524	VR524	L0524	TA524	EC524-620
115	FSNT 526	22226K	SR230X13	H3126	TSNG526	VR526	L0526	TA526	EC526
	FSNT 526	23226K	SR230X5	H2326	TSNG526	VR526	L0526	TA526	EC526
125	FSNT 528	22228K	SR250X15	H3128	TSNG528	VR528	L0528	TA528	EC528
	FSNT 528	23228K	SR250X5	H2328	TSNG528	VR528	L0528	TA528	EC528
135	FSNT 530	22230K	SR270X16.5	H3130	TSNG530	VR530	L0530	TA530	EC530
	FSNT 530	23230K	SR270X5	H2330	TSNG530	VR530	L0530	TA530	EC530
140	FSNT 532	22232K	SR290X17	H3132	TSNG532	VR532	L0532	TA532	EC532
	FSNT 532	23232K	SR290X5	H2332	TSNG532	VR532	L0532	TA532	EC532

⁽¹⁾ Locating rings = two required for fixed position, sold one piece per box.

⁽²⁾ Adapter sleeve assembly includes one sleeve, one locknut and one lockwasher.

⁽³⁾ Double-lip and V-ring seals sold two seals per box.

⁽⁴⁾ Labyrinth, taconite seal and end cover sold one seal per box.

3D CAD and 2D drawings available at <http://cad.timken.com/category/snt-housed-units>

500/600 SERIES (CONTINUED)

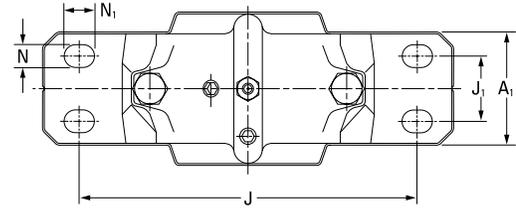
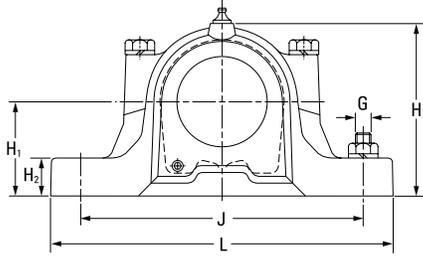

Housing Dimensions												4 Bolts Req'd	Housing Mass
A	A ₁	A ₂	A ₃	H	H ₁	H ₂	J	J ₁	L	N	N ₁	G	
mm	mm	mm	mm	mm	mm	mm	mm	mm	mm	mm	mm	mm	kg
140	100	158	225	194	100	35	290	50	345	18	24	16	13.1
140	100	158	225	194	100	35	290	50	345	18	24	16	13.1
145	100	163	220	212	112	35	290	50	345	18	24	16	14
175	120	191	250	242	125	45	350	70	410	18	24	16	22.3
175	120	191	250	242	125	45	350	70	410	18	24	16	22.3
160	110	178	235	218	112	40	320	60	380	18	24	16	17.6
160	110	178	235	218	112	40	320	60	380	18	24	16	17.6
185	120	199	260	271	140	45	350	70	410	18	24	16	26.5
185	120	199	260	271	140	45	350	70	410	18	24	16	26.5
175	120	191	250	242	125	45	350	70	410	18	24	16	22.3
175	120	191	250	242	125	45	350	70	410	18	24	16	22.3
185	120	199	260	271	140	45	350	70	410	18	24	16	26.5
185	120	199	260	271	140	45	350	70	410	18	24	16	26.5
190	130	208	265	290	150	50	380	70	445	22	28	20	34
190	130	208	265	290	150	50	380	70	445	22	28	20	34
205	150	223	285	302	150	50	420	80	500	26	32	24	39
205	150	223	285	302	150	50	420	80	500	26	32	24	39
220	160	241	295	323	160	60	450	90	530	26	32	24	48
220	160	241	295	323	160	60	450	90	530	26	32	24	48
235	160	254	315	344	170	60	470	90	550	26	32	24	54.5
235	160	254	315	344	170	60	470	90	550	26	32	24	54.5

TWO-BOLT SNT HOUSINGS FOR CYLINDRICAL BORE BEARINGS

- The part numbers for ordering split plummer block housings and components are listed in the table below.
- Each housing includes the housing cap, housing base and cap bolts.
- Specify bearing suffix W33 for center lubrication of groove and holes, and use the housing center port for the grease fitting.

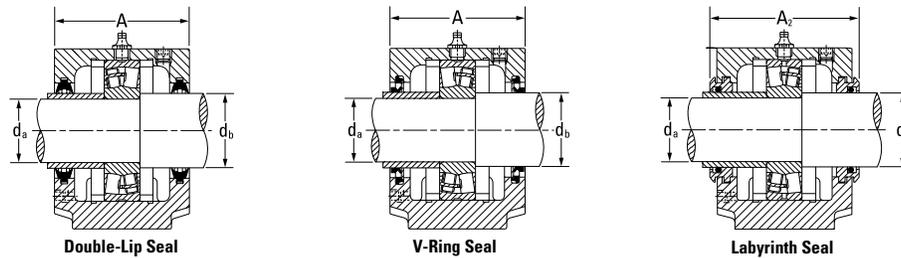

Shaft Dia.		Housing	Bearing	Locating Rings ⁽¹⁾ O.D. x Width	Double-Lip Seal ⁽²⁾	V-Ring Seal ⁽²⁾	Labyrinth Seal ⁽³⁾	End Cover ⁽³⁾
d _a	d _b							
mm	mm							
25	30	SNT 205 SNT 206-305	22205 21305	SR52X3.5 SR62X7.5	TSNG205 TSNG507-305	– VR305	L0205 L0305	EC506-605 EC507-606
30	35	SNT 206-305 SNT 507-606	22206 21306	SR62X6 SR72X7.5	TSNG306-206 TSNG306-206	VR206 VR306	L0206 L0306	EC507-606 EC507-606
35	45	SNT 207 SNT 208-307	22207 21307	SR72X5.5 SR80X9	TSNG207 TSNG510-307	VR207 VR307	L0207 L0307	EC509 EC510-608
40	50	SNT 208-307 SNT 510-608 SNT 510-608	22208 21308 22308	SR80X8 SR90X9 SR90X4	TSNG308-208 TSNG308-208 TSNG308-208	VR208 VR308 VR308	L0208 L0308 L0308	EC510-608 EC510-608 EC510-608
45	55	SNT 209 SNT 511-609 SNT 511-609	22209 21309 22309	SR85X3.5 SR100X9.5 SR100X4	TSNG309-209 TSNG309-209 TSNG309-209	VR209 VR309 VR309	L0209 L0309 L0309	EC511-609 EC511-609 EC511-609
50	60	SNT 210 SNT 512-610 SNT 512-610	22210 21310 22310	SR90X9 SR110X10.5 SR110X4	TSNG310-210 TSNG310-210 TSNG310-210	VR210 VR310 VR310	L0210 L0310 L0310	EC512-610 EC512-610 EC512-610
55	65	SNT 211 SNT 513-611 SNT 513-611	22211 21311 22311	SR100X9.5 SR120X11 SR120X4	TSNG311-211 TSNG311-211 TSNG311-211	VR211 VR311 VR311	L0211 L0311 L0311	EC513-611 EC513-611 EC513-611
60	70	SNT 212 SNT 515-612 SNT 515-612	22212 21312 22312	SR110X10 SR130X12.5 SR130X5	TSNG312-212 TSNG312-212 TSNG312-212	VR212 VR312 VR312	L0212 L0312 L0312	EC515-612 EC515-612 EC515-612
65	75	SNT 213 SNT 516-613 SNT 516-613	22213 21313 22313	SR120X10 SR140X12.5 SR140X5	TSNG313-213 TSNG313-213 TSNG313-213	VR213 VR313 VR313	L0213 L0313 L0313	EC516-613 EC516-613 EC516-613
70	80	SNT 517 SNT 517	22314 21314	SR150X5 SR150X13	TSNG314 TSNG314	VR314 VR314	L0314 L0314	EC517 EC517

⁽¹⁾Locating rings = two required for fixed position, sold one piece per box.

⁽²⁾Double-lip and V-ring seals sold two seals per box.

⁽³⁾Labyrinth, taconite seal and end cover sold one seal per box.

3D CAD and 2D drawings available at <http://cad.timken.com/category/snt-housed-units>

200/300 SERIES

- Grease hole fittings and plugs use 1/8 BSPT thread size for all housings up to 520-617. Housings 522-619 and larger use 1/4 BSPT thread size.

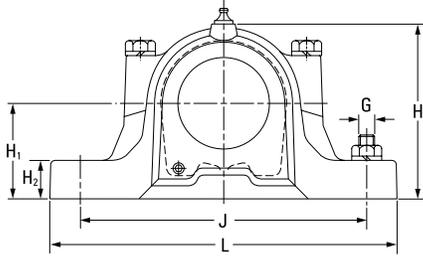

- Assemblies shown are furnished in cast iron. If ductile iron is desired, add the letter D to the alpha prefix (e.g., SNTD 505).
- Seal sleeve for d_a shaft to be supplied by customer and should have same O.D. as d_b .

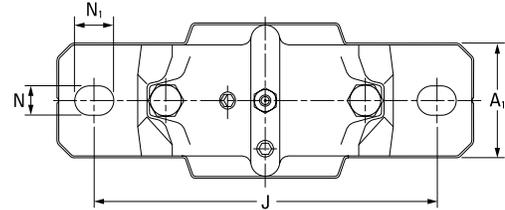

Housing Dimensions											2 Bolts Req'd	Housing Mass
A	A ₁	A ₂	A ₃	H	H ₁	H ₂	J	L	N	N ₁	G	kg
mm	mm	mm	mm	mm	mm	mm	mm	mm	mm	mm	mm	kg
67	46	90	140	74	40	19	130	165	15	20	12	1.5
77	52	89	150	89	50	22	150	185	15	20	12	2
77	52	89	150	89	50	22	150	185	15	20	12	2
82	52	94	140	93	50	22	150	185	15	20	12	2.2
82	52	96	155	93	50	22	150	185	15	20	12	2.2
85	60	99	160	108	60	25	170	205	15	20	12	2.9
85	60	99	160	108	60	25	170	205	15	20	12	2.9
90	60	102	150	113	60	25	170	205	15	20	12	3.2
90	60	102	150	113	60	25	170	205	15	20	12	3.2
85	60	97	160	109	60	25	170	205	15	20	12	2.9
95	70	107	155	128	70	28	210	255	18	24	16	4.5
95	70	107	155	128	70	28	210	255	18	24	16	4.5
90	60	102	165	113	60	25	170	205	15	20	12	3.2
105	70	117	165	134	70	30	210	255	18	24	16	5.3
105	70	117	165	134	70	30	210	255	18	24	16	5.3
95	70	107	170	128	70	28	210	255	18	24	16	4.5
110	80	122	170	150	80	30	230	275	18	24	16	6.6
110	80	122	170	150	80	30	230	275	18	24	16	6.6
105	70	117	180	134	70	30	210	255	18	24	16	5.2
115	80	127	175	156	80	30	230	280	18	24	16	6.9
115	80	127	175	156	80	30	230	280	18	24	16	6.9
110	80	128	190	149	80	30	230	275	18	24	16	6.6
120	90	138	180	177	95	32	260	315	22	28	20	9.7
120	90	138	180	177	95	32	260	315	22	28	20	9.7
125	90	143	210	183	95	32	260	320	22	28	20	10.4
125	90	143	210	183	95	32	260	320	22	28	20	10.4

Continued on next page.

TWO-BOLT SNT HOUSINGS FOR CYLINDRICAL BORE BEARINGS

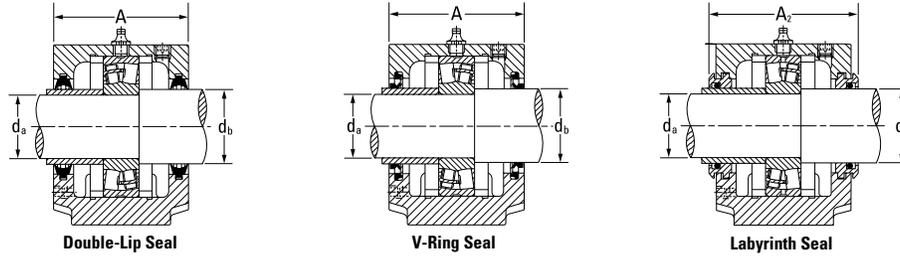

Continued from previous page.

Shaft Dia.		Housing	Bearing	Locating Rings ⁽¹⁾ O.D. x Width	Double-Lip Seal ⁽²⁾	V-Ring Seal ⁽²⁾	Labyrinth Seal ⁽³⁾	End Cover ⁽³⁾
d _a	d _b							
mm	mm							
75	85	SNT 215	22215	SR130X12.5	TSNG315-215	VR215	L0215	EC518-615
		SNT 518-615	21315	SR160X14	TSNG315-215	VR315	L0315	EC518-615
		SNT 518-615	22315	SR160X5	TSNG315-215	VR315	L0315	EC518-615
80	90	SNT 216	22216	SR140X10	TSNG216	VR216	L0216	EC216
		SNT 519-616	21316	SR170X14.5	TSNG316	VR316	L0316	EC519-616
		SNT 519-616	22316	SR170X5	TSNG316	VR316	L0316	EC519-616
85	95	SNT 217	22217	SR150X12.5	TSNG217	VR217	L0217	EC217
		SNT 520-617	21317	SR180X14.5	TSNG317	VR317	L0317	EC520-617
		SNT 520-617	22317	SR180X5	TSNG317	VR317	L0317	EC520-617
90	100	SNT 218	22218	SR160X12.5	TSNG218	VR218	L0218	EC218
		SNT 218	23218	SR160X6.25	TSNG218	VR218	L0218	EC218
95	110	SNT 522-619	21319	SR200X17.5	TSNG319	VR319	L0319	EC522-619
		SNT 522-619	22319	SR200X6.5	TSNG319	VR319	L0319	EC522-619
100	115	SNT 520-617	22220	SR180X12	TSNG220	VR220	L0220	EC520-617
		SNT 520-617	23220	SR180X4.85	TSNG220	VR220	L0220	EC520-617
		SNT 524-620	21320	SR215X19.5	TSNG320	VR320	L0320	EC524-620
		SNT 524-620	22320	SR215X6.5	TSNG320	VR320	L0320	EC524-620
110	125	SNT 522-619	22222	SR200X13.5	TSNG222	VR222	L0222	EC522-619
		SNT 522-619	23222	SR200X5.1	TSNG222	VR222	L0222	EC522-619
120	135	SNT 524-620	22224	SR215X14	TSNG224	VR224	L0224	EC524-620
		SNT 524-620	23224	SR215X5	TSNG224	VR224	L0224	EC524-620
130	145	SNT 526	22226	SR230X13	TSNG226	VR226	L0226	EC526
		SNT 526	23226	SR230X5	TSNG226	VR226	L0226	EC526
140	155	SNT 528	22228	SR250X15	TSNG228	VR228	L0228	EC528
		SNT 528	23228	SR250X5	TSNG228	VR228	L0228	EC528
150	165	SNT 530	22230	SR270X16.5	TSNG230	VR230	L0230	EC530
		SNT 530	23230	SR270X5	TSNG230	VR230	L0230	EC530
160	175	SNT 532	22232	SR290X17	TSNG232	VR232	L0232	EC532
		SNT 532	23232	SR290X5	TSNG232	VR232	L0232	EC532

⁽¹⁾ Locating rings = two required for fixed position, sold one piece per box.

⁽²⁾ Double-lip and V-ring seals sold two seals per box.

⁽³⁾ Labyrinth, taconite seal and end cover sold one seal per box.

3D CAD and 2D drawings available at <http://cad.timken.com/category/snt-housed-units>

200/300 SERIES (CONTINUED)

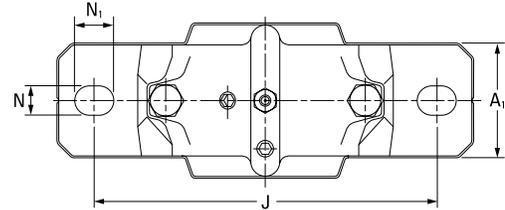
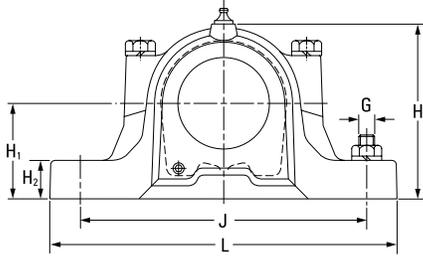

Housing Dimensions											2 Bolts Req'd	Housing Mass
A	A ₁	A ₂	A ₃	H	H ₁	H ₂	J	L	N	N ₁	G	
mm	mm	mm	mm	mm	mm	mm	mm	mm	mm	mm	mm	kg
115	80	133	195	155	80	30	230	280	18	24	16	6.9
140	100	158	225	194	100	35	290	345	22	28	20	13.1
140	100	158	225	194	100	35	290	345	22	28	20	13.1
120	90	138	200	177	95	32	260	315	22	28	20	9.7
145	100	163	220	212	112	35	290	345	22	28	20	14.0
145	100	163	220	212	112	35	290	345	22	28	20	14.0
125	90	143	205	183	95	32	260	320	22	28	20	10.4
160	110	178	235	218	112	40	320	380	26	32	24	17.6
160	110	178	235	218	112	40	320	380	26	32	24	17.6
140	100	158	220	194	100	35	290	345	22	28	20	13.1
140	100	158	220	194	100	35	290	345	22	28	20	13.1
175	120	191	250	242	125	45	350	410	26	32	24	22.3
175	120	191	250	242	125	45	350	410	26	32	24	22.3
160	110	178	235	218	112	40	320	380	26	32	24	17.6
160	110	178	235	218	112	40	320	380	26	32	24	17.6
185	120	199	260	271	140	45	350	410	26	32	24	26.5
185	120	199	260	271	140	45	350	410	26	32	24	26.5
175	120	191	250	242	125	45	350	410	26	32	24	22.3
175	120	191	250	242	125	45	350	410	26	32	24	22.3
185	120	199	260	271	140	45	350	410	26	32	24	26.5
185	120	199	260	271	140	45	350	410	26	32	24	26.5
190	130	208	265	290	150	50	380	445	28	35	24	34.0
190	130	208	265	290	150	50	380	445	28	35	24	34.0
205	150	223	285	302	150	50	420	500	35	42	30	39.0
205	150	223	285	302	150	50	420	500	35	42	30	39.0
220	160	241	295	323	160	60	450	530	35	42	30	48.0
220	160	241	295	323	160	60	450	530	35	42	30	48.0
235	160	254	315	344	170	60	470	550	35	42	30	54.5
235	160	254	315	344	170	60	470	550	35	42	30	54.5

FOUR-BOLT FSNT HOUSINGS FOR CYLINDRICAL BORE BEARINGS

- The part numbers for ordering split plummer block housings and components are listed in the table below.
- Each housing includes the housing cap, housing base and cap bolts.
- Specify bearing suffix W33 for center lubrication of groove and holes, and use the housing center port for the grease fitting.

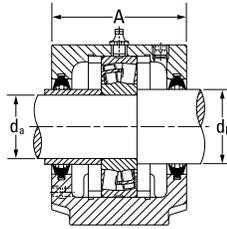

Double-Lip Seal

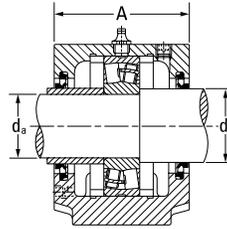

V-Ring Seal

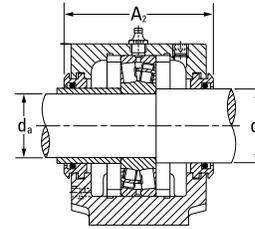

Labyrinth Seal

Shaft Dia.		Housing	Bearing	Locating Rings ⁽¹⁾ O.D. x Width	Double-Lip Seal ⁽²⁾	V-Ring Seal ⁽²⁾	Labyrinth Seal ⁽³⁾	End Cover ⁽³⁾
d _a	d _b							
mm	mm							
45	55	FSNT 511-609 FSNT 511-609	21309 22309	SR100X9.5 SR100X4	TSNG309-209 TSNG309-209	VR309 VR309	L0309 L0309	EC511-609 EC511-609
50	60	FSNT 512-610 FSNT 512-610	21310 22310	SR110X10.5 SR110X4	TSNG310-210 TSNG310-210	VR310 VR310	L0310 L0310	EC512-610 EC512-610
55	65	FSNT 513-611 FSNT 513-611	21311 22311	SR120X11 SR120X4	TSNG311-211 TSNG311-211	VR311 VR311	L0311 L0311	EC513-611 EC513-611
60	70	FSNT 515-612 FSNT 515-612	21312 22312	SR130X12.5 SR130X5	TSNG312-212 TSNG312-212	VR312 VR312	L0312 L0312	EC515-612 EC515-612
65	75	FSNT 516-613 FSNT 516-613	21313 22313	SR140X12.5 SR140X5	TSNG313-213 TSNG313-213	VR313 VR313	L0313 L0313	EC516-613 EC516-613
70	80	FSNT 517 FSNT 517	22314 21314	SR150X5 SR150X13	TSNG314 TSNG314	VR314 VR314	L0314 L0314	EC517 EC517
75	85	FSNT 518-615 FSNT 518-615	21315 22315	SR160X14 SR160X5	TSNG315-215 TSNG315-215	VR315 VR315	L0315 L0315	EC518-615 EC518-615
80	90	FSNT 519-616 FSNT 519-616	21316 22316	SR170X14.5 SR170X5	TSNG316 TSNG316	VR316 VR316	L0316 L0316	EC519-616 EC519-616

⁽¹⁾Locating rings = two required for fixed position, sold one piece per box.

⁽²⁾Double-lip and V-ring seals sold two seals per box.

⁽³⁾Labyrinth, taconite seal and end cover sold one seal per box.

3D CAD and 2D drawings available at <http://cad.timken.com/category/snt-housed-units>

200/300 SERIES

- Grease hole fittings and plugs use 1/8 BSPT thread size for all housings up to 520-617. Housings 522-619 and larger use 1/4 BSPT thread size.
- Assemblies shown are furnished in cast iron. If ductile iron is desired, add the letter D to the alpha prefix (e.g., SNTD 505).
- Seal sleeve for d_a shaft to be supplied by customer and should have same O.D. as d_b .

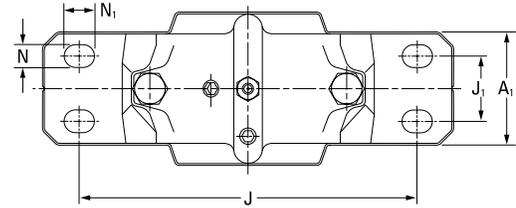
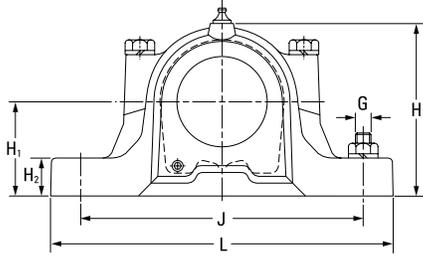

Housing Dimensions												4 Bolts Req'd	Housing Mass
A	A ₁	A ₂	A ₃	H	H ₁	H ₂	J	J ₁	L	N	N ₁	G	
mm	mm	mm	mm	mm	mm	mm	mm	mm	mm	mm	mm	mm	kg
95	70	107	155	128	70	28	210	35	255	15	20	12	4.5
95	70	107	155	128	70	28	210	35	255	15	20	12	4.5
105	70	117	165	134	70	30	210	35	255	15	20	12	5.3
105	70	117	165	134	70	30	210	35	255	15	20	12	5.3
110	80	122	170	150	80	30	230	40	275	15	20	12	6.6
110	80	122	170	150	80	30	230	40	275	15	20	12	6.6
115	80	127	175	156	80	30	230	40	280	15	20	12	6.9
115	80	127	175	156	80	30	230	40	280	15	20	12	6.9
120	90	138	180	177	95	32	260	50	315	18	24	16	9.7
120	90	138	180	177	95	32	260	50	315	18	24	16	9.7
125	90	143	210	183	95	32	260	50	320	18	24	16	10.4
125	90	143	210	183	95	32	260	50	320	18	24	16	10.4
140	100	158	225	194	100	35	290	50	345	18	24	16	13.1
140	100	158	225	194	100	35	290	50	345	18	24	16	13.1
145	100	163	220	212	112	35	290	50	345	18	24	16	14.0
145	100	163	220	212	112	35	290	50	345	18	24	16	14.0

Continued on next page.

FOUR-BOLT FSNT HOUSINGS FOR CYLINDRICAL BORE BEARINGS

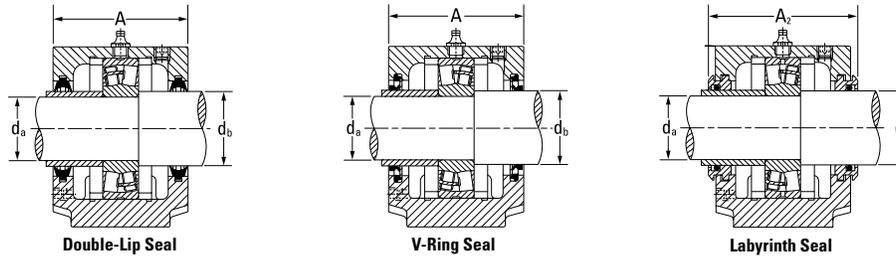

Continued from previous page.

Shaft Dia.		Housing	Bearing	Locating Rings ⁽¹⁾ O.D. x Width	Double-Lip Seal ⁽²⁾	V-Ring Seal ⁽²⁾	Labyrinth Seal ⁽³⁾	End Cover ⁽³⁾
d _a	d _b							
mm	mm							
85	95	FSNT 520-617	21317	SR180X14.5	TSNG317	VR317	L0317	EC520-617
		FSNT 520-617	22317	SR180X5	TSNG317	VR317	L0317	EC520-617
95	110	FSNT 522-619	21319	SR200X17.5	TSNG319	VR319	L0319	EC522-619
		FSNT 522-619	22319	SR200X6.5	TSNG319	VR319	L0319	EC522-619
100	115	FSNT 520-617	22220	SR180X12	TSNG220	VR220	L0220	EC520-617
		FSNT 520-617	23220	SR180X4.85	TSNG220	VR220	L0220	EC520-617
		FSNT 524-620	21320	SR215X19.5	TSNG320	VR320	L0320	EC524-620
		FSNT 524-620	22320	SR215X6.5	TSNG320	VR320	L0320	EC524-620
110	125	FSNT 522-619	22222	SR200X13.5	TSNG222	VR222	L0222	EC522-619
		FSNT 522-619	23222	SR200X5.1	TSNG222	VR222	L0222	EC522-619
120	135	FSNT 524-620	22224	SR215X14	TSNG224	VR224	L0224	EC524-620
		FSNT 524-620	23224	SR215X5	TSNG224	VR224	L0224	EC524-620
130	145	FSNT 526	22226	SR230X13	TSNG226	VR226	L0226	EC526
		FSNT 526	23226	SR230X5	TSNG226	VR226	L0226	EC526
140	155	FSNT 528	22228	SR250X15	TSNG228	VR228	L0228	EC528
		FSNT 528	23228	SR250X5	TSNG228	VR228	L0228	EC528
150	165	FSNT 530	22230	SR270X16.5	TSNG230	VR230	L0230	EC530
		FSNT 530	23230	SR270X5	TSNG230	VR230	L0230	EC530
160	175	FSNT 532	22232	SR290X17	TSNG232	VR232	L0232	EC532
		FSNT 532	23232	SR290X5	TSNG232	VR232	L0232	EC532

⁽¹⁾Locating rings = two required for fixed position, sold one piece per box.

⁽²⁾Double-lip and V-ring seal sold two seals per box.

⁽³⁾Labyrinth, taconite seal and end cover sold one seal per box.

3D CAD and 2D drawings available at <http://cad.timken.com/category/snt-housed-units>

200/300 SERIES (CONTINUED)

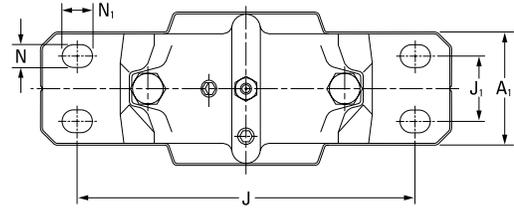
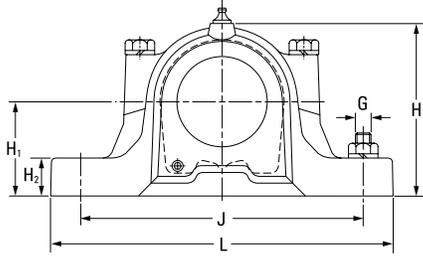

Housing Dimensions												4 Bolts Req'd	Housing Mass
A	A ₁	A ₂	A ₃	H	H ₁	H ₂	J	J ₁	L	N	N ₁	G	
mm	mm	mm	mm	mm	mm	mm	mm	mm	mm	mm	mm	mm	kg
160	110	178	235	218	112	40	320	60	380	18	24	16	17.6
160	110	178	235	218	112	40	320	60	380	18	24	16	17.6
175	120	191	250	242	125	45	350	70	410	18	24	16	22.3
175	120	191	250	242	125	45	350	70	410	18	24	16	22.3
160	110	178	235	218	112	40	320	60	380	18	24	16	17.6
160	110	178	235	218	112	40	320	60	380	18	24	16	17.6
185	120	199	260	271	140	45	350	70	410	18	24	16	26.5
185	120	199	260	271	140	45	350	70	410	18	24	16	26.5
175	120	191	250	242	125	45	350	70	410	18	24	16	22.3
175	120	191	250	242	125	45	350	70	410	18	24	16	22.3
185	120	199	260	271	140	45	350	70	410	18	24	16	26.5
185	120	199	260	271	140	45	350	70	410	18	24	16	26.5
190	130	208	265	290	150	50	380	70	445	22	28	20	34
190	130	208	265	290	150	50	380	70	445	22	28	20	34
205	150	223	285	302	150	50	420	80	500	26	32	24	39
205	150	223	285	302	150	50	420	80	500	26	32	24	39
220	160	241	295	323	160	60	450	90	530	26	32	24	48
220	160	241	295	323	160	60	450	90	530	26	32	24	48
235	160	254	315	344	170	60	470	90	550	26	32	24	54.5
235	160	254	315	344	170	60	470	90	550	26	32	24	54.5

FOUR-BOLT SNTD HOUSINGS FOR TAPERED BORE BEARINGS

- The part numbers for ordering split plummer block housings and components are listed in the table below.
- Each housing includes the housing cap, housing base and cap bolts.

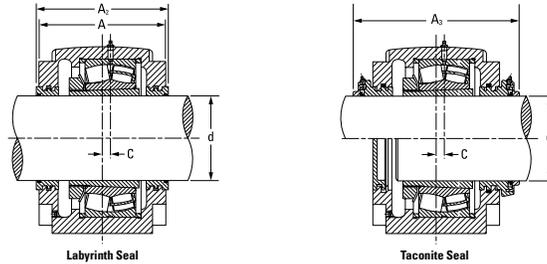

Shaft Dia.	Housing	Bearing	Locating Rings ⁽¹⁾	Quantity Locating Rings Required for Fixed	Adapter Sleeve ⁽²⁾	Labyrinth Seal ⁽³⁾	Taconite Seal ⁽³⁾	End Cover ⁽³⁾
d			O.D. x Width					
mm								
115	SNTD 3134	22326K	SR280X7.5	2	H2326	L034/115	TA34/115	EC34
125	SNTD 3136	22328K	SR300X7	2	H2328	L036/125	TA36/125	EC36
135	SNTD 3138	22330K	SR320X8	2	H2330	L038/135	TA38/135	EC38
140	SNTD 3038	22232K	SR290X17.5	2	H3132	L038/140	TA38/140	EC38
	SNTD 3038	23232K	SR290X5.5	2	H2332	L038/140	TA38/140	EC38
	SNTD 3140	22332K	SR340X9	2	H2332	L040/140	TA40/140	EC40
150	SNTD 3134	23134K	SR280X10	2	H3134	L034	TA34	EC34
	SNTD 3040	22234K	SR310X18	2	H3134	L040/150	TA40/150	EC40
	SNTD 3048	22334K	SR360X10	2	H2334	L048/150	TA48/150	EC48
160	SNTD 3036	23036K	SR280X17	2	H3036	L036	TA36	EC36
	SNTD 3136	23136K	SR300X10	2	H3136	L036	TA36	EC36
	SNTD 3138	22236K	SR320X19	2	H3136	L038/160	TA38/160	EC38
170	SNTD 3038	23038K	SR290X10	4	H3038	L038	TA38	EC38
	SNTD 3138	23138K	SR320X10	2	H3138	L038	TA38	EC38
	SNTD 3140	22238K	SR340X10	4	H3138	L040/170	TA40/170	EC40
	SNTD 3148	22338K	SR400X8	2	H2338	L048/170	TA48/170	EC48
180	SNTD 3040	23040K	SR310X10	4	H3040	L040	TA40	EC40
	SNTD 3140	23140K	SR340X10	2	H3140	L040	TA40	EC40
	SNTD 3048	22240K	SR360X21	2	H3140	L048/180	TA48/180	EC48
	SNTD 3056	22340K	SR420X14	2	H2340	L056/180	TA56/180	EC56
200	SNTD 3044	23044K	SR340X10	4	OH3044H	L044	TA44	EC44
	SNTD 3144	23144K	SR370X10	2	OH3144H	L044	TA44	EC44
	SNTD 3148	22244K	SR400X10	4	OH3144H	L048/200	TA48/200	EC48
	SNTD 3156	22344K	SR460X10.5	2	OH2344H	L056/200	TA56/200	EC56
220	SNTD 3048	23048K	SR360X12	4	OH3048H	L048	TA48	EC48
	SNTD 3148	23148K	SR400X10	2	OH3148H	L048	TA48	EC48
	SNTD 3152	22248K	SR440X22	2	OH3148H	L052/220	TA52/220	EC52
	SNTD 3160	22348K	SR500X12.5	2	OH2348H	L060/220	TA60/220	EC60

⁽¹⁾Locating rings = sold one piece per box.

⁽²⁾Adapter sleeve assembly includes one sleeve, one locknut and one lockwasher.

⁽³⁾Labyrinth, taconite seal and end cover sold one seal per box.

3D CAD and 2D drawings available at <http://cad.timken.com/category/snt-housed-units>

3000 AND 3100 SERIES

- SNTD housings are supplied in ductile iron.
- Housings with the F suffix are manufactured for fixed bearings. Those with the L suffix are float position housings.

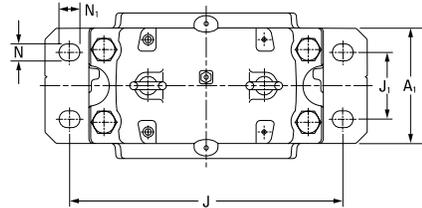
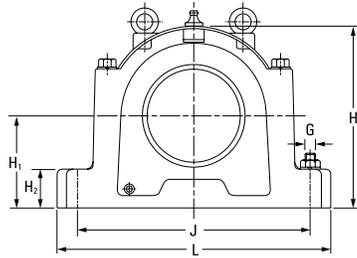

Housing Dimensions													4 Bolts Req'd	Housing Mass kg
A	A ₁	A ₂	A ₃	C	H	H ₁	H ₂	J	J ₁	L	N	N ₁	G	
mm	mm	mm	mm	mm	mm	mm	mm	mm	mm	mm	mm	mm	mm	mm
230	180	242.5	299.5	14	333	170	70	430	100	510	28	34	24	75.0
240	190	252.5	314.5	15	353	180	75	450	110	530	28	34	24	92.0
260	210	271.5	333.5	10	375	190	80	480	120	560	28	34	24	112.0
240	190	252	314	15	354	180	75	450	110	530	28	34	24	85.9
240	190	252	314	15	354	180	75	450	110	530	28	34	24	85.9
280	230	291.5	358.5	10	411	210	85	510	130	610	35	42	30	130.0
230	180	242.5	299.5	14	333	170	70	430	100	510	28	34	24	75.0
260	210	271	338	10	375	190	80	480	120	560	28	34	24	102.6
290	240	300	379.5	12	434	220	90	540	140	640	35	42	30	146.5
230	180	242	304	14	333	170	70	430	100	510	28	34	24	68.1
240	190	252.5	314.5	15	353	180	75	450	110	530	28	34	24	92.0
260	210	271.5	333.5	10	375	190	80	480	120	560	28	34	24	112.0
240	190	252	314	15	354	180	75	450	110	530	28	34	24	85.9
260	210	271.5	333.5	10	375	190	80	480	120	560	28	34	24	112.0
280	230	291.5	358.5	10	411	210	85	510	130	610	35	42	30	130.0
310	260	318.5	398	12	474	240	95	600	150	700	35	42	30	193.0
260	210	271	338	10	375	190	80	480	120	560	28	34	24	102.6
280	230	291.5	358.5	10	411	210	85	510	130	610	35	42	30	130.0
290	240	300	379.5	12	434	220	90	540	140	640	35	42	30	146.5
320	280	332.5	412	13	516	260	100	650	160	770	42	50	36	244.9
280	230	291	353	10	411	210	85	510	130	610	35	42	30	123.7
290	240	300.5	362.5	12	434	220	90	540	140	640	35	42	30	140.0
310	260	318.5	398	12	474	240	95	600	150	700	35	42	30	193.0
320	280	332.5	412	16	551	280	105	670	160	790	42	50	36	260.0
290	240	300	379.5	12	434	220	90	540	140	640	35	42	30	146.5
310	260	318.5	398	12	474	240	95	600	150	700	35	42	30	193.0
320	280	332.5	412	13	516	260	100	650	160	770	42	50	36	235.0
350	310	363	442.5	22	591	300	110	710	190	830	42	50	36	310.0

Continued on next page.

FOUR-BOLT SNTD HOUSINGS FOR TAPERED BORE BEARINGS

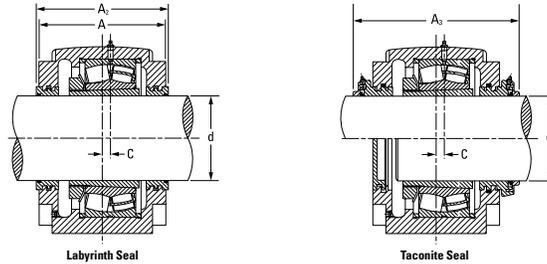

Continued from previous page.

Shaft Dia.	Housing	Bearing	Locating Rings ⁽¹⁾	Quantity Locating Rings Required for Fixed	Adapter Sleeve ⁽²⁾	Labyrinth Seal ⁽³⁾	Taconite Seal ⁽³⁾	End Cover ⁽³⁾
d			O.D. x Width					
mm								
240	SNTD 3052	23052K	SR400X22	2	OH3052H	L052	TA52	EC52
	SNTD 3152	23152K	SR440X10	2	OH3152H	L052	TA52	EC52
	SNTD 3064	22252K	SR480X25.5	2	OH3152H	L064/240	TA64/240	EC64
	SNTD 3164	22352K	SR540X15.5	2	OH2352H	L064/240	TA64/240	EC64
260	SNTD 3056	23056K	SR420X10	6	OH3056H	L056	TA56	EC56
	SNTD 3156	23156K	SR460X10	2	OH3156H	L056	TA56	EC56
	SNTD 3160	22256K	SR500X25	2	OH3156H	L060/260	TA60/260	EC60
280	SNTD 3060	23060K	SR460X25	2	OH3060H	L060	TA60	EC60
	SNTD 3160	23160K	SR500X10	2	OH3160H	L060	TA60	EC60
	SNTD 3164	22260K	SR540X28	2	OH3160H	L064/280	TA64/280	EC64
300	SNTD 3064	23064K	SR480X10	6	OH3064H	L064	TA64	EC64
	SNTD 3164	23164K	SR540X10	2	OH3164H	L064	TA64	EC64
	SNTD 3168F	22264K	SR580X20	2	OH3164H	L068/300	TA68/300	EC68
320	SNTD 3068	23068K	SR520X16	4	OH3068H	L068	TA68	EC68
	SNTD 3168F	23168K	FIXED HOUSING	-	OH3168H	L068	TA68	EC68
	SNTD 3168L	23168K	FLOAT HOUSING	-	OH3168H	L068	TA68	EC68
340	SNTD 3072	23072K	SR540X16	4	OH3072H	L072	TA72	EC72
	SNTD 3172F	23172K	FIXED HOUSING	-	OH3172H	L072	TA72	EC72
	SNTD 3172L	23172K	FLOAT HOUSING	-	OH3172H	L072	TA72	EC72
	SNTD 3180F	22272K	FIXED HOUSING	-	OH3172H	L080/340	TA80/340	EC80
	SNTD 3180L	22272K	FLOAT HOUSING	-	OH3172H	L080/340	TA80/340	EC80
360	SNTD 3076F	23076K	FIXED HOUSING	-	OH3076H	L076	TA76	EC76
	SNTD 3076L	23076K	FLOAT HOUSING	-	OH3076H	L076	TA76	EC76
	SNTD 3176F	23176K	FIXED HOUSING	-	OH3176H	L076	TA76	EC76
	SNTD 3176L	23176K	FLOAT HOUSING	-	OH3176H	L076	TA76	EC76
380	SNTD 3080F	23080K	FIXED HOUSING	-	OH3080H	L080	TA80	EC80
	SNTD 3080L	23080K	FLOAT HOUSING	-	OH3080H	L080	TA80	EC80
	SNTD 3180F	23180K	FIXED HOUSING	-	OH3180H	L080	TA80	EC80
	SNTD 3180L	23180K	FLOAT HOUSING	-	OH3180H	L080	TA80	EC80

⁽¹⁾ Locating rings = sold one piece per box.

⁽²⁾ Adapter sleeve assembly includes one sleeve, one locknut and one lockwasher.

⁽³⁾ Labyrinth, taconite seal and end cover sold one seal per box.

3D CAD and 2D drawings available at <http://cad.timken.com/category/snt-housed-units>

3000 AND 3100 SERIES (CONTINUED)

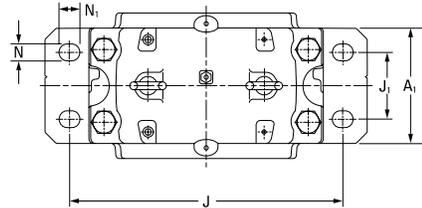
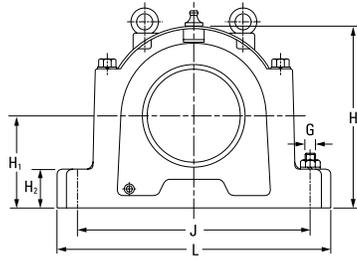

Housing Dimensions													4 Bolts Req'd	Housing Mass
A	A ₁	A ₂	A ₃	C	H	H ₁	H ₂	J	J ₁	L	N	N ₁	G	kg
mm	mm	mm	mm	mm	mm	mm	mm	mm	mm	mm	mm	mm	mm	kg
310	260	318.5	398	12	473	240	95	600	150	700	35	42	30	183.6
320	280	332.5	412	13	516	260	100	650	160	770	42	50	36	235.0
350	310	362.5	442	22	590	300	110	710	190	830	42	50	36	330.7
370	330	383	462.5	23	631	320	115	750	200	880	42	50	36	346.0
320	280	332.5	412	13	516	260	100	650	160	770	42	50	36	244.9
320	280	332.5	412	16	551	280	105	670	160	790	42	50	36	260.0
350	310	363	442.5	22	591	300	110	710	190	830	42	50	36	310.0
320	280	332.5	412	16	550	280	105	670	160	790	42	50	36	247.8
350	310	363	442.5	22	591	300	110	710	190	830	42	50	36	310.0
370	330	383	462.5	23	631	320	115	750	200	880	42	50	36	346.0
350	310	362.5	442	22	590	300	110	710	190	830	42	50	36	330.7
370	330	383	462.5	23	631	320	115	750	200	880	42	50	36	346.0
400	360	412	491.5	25	675	340	120	810	220	950	42	50	36	432.5
370	330	382.5	462	23	630	320	115	750	200	880	42	50	36	389.5
400	360	412	491.5	25	675	340	120	810	220	950	42	50	36	432.5
400	360	412	491.5	25	675	340	120	810	220	950	42	50	36	429.5
370	330	381.5	461	23	630	320	115	750	200	880	42	50	36	349.7
400	360	412	491.5	30	695	350	120	840	220	1000	42	50	36	458.0
400	360	412	491.5	30	695	350	120	840	220	1000	42	50	36	454.0
430	390	442	521.5	30	775	380	125	950	240	1120	48	60	42	595.0
430	390	442	521.5	30	775	380	125	950	240	1120	48	60	42	595.0
400	360	412	491.5	24	675	340	120	810	220	950	42	50	36	477.4
400	360	412	491.5	24	675	340	120	810	220	950	42	50	36	477.4
400	360	412	491.5	30	715	360	120	870	220	1040	42	50	36	487.0
400	360	412	491.5	30	715	360	120	870	220	1040	42	50	36	484.0
400	360	412	491.5	30	695	350	120	840	220	1000	42	50	36	457.3
400	360	412	491.5	30	695	350	120	840	220	1000	42	50	36	457.3
430	390	442	521.5	30	775	380	125	950	240	1120	48	60	42	595.0
430	390	442	521.5	30	775	380	125	950	240	1120	48	60	42	595.0

Continued on next page.

FOUR-BOLT SNTD HOUSINGS FOR TAPERED BORE BEARINGS

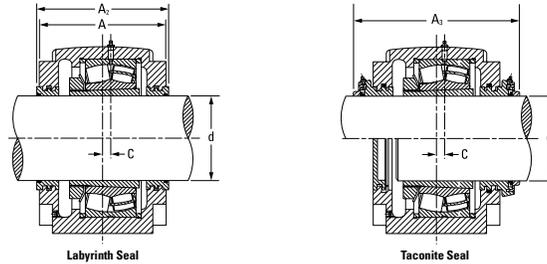

Continued from previous page.

Shaft Dia.	Housing	Bearing	Locating Rings ⁽¹⁾ O.D. x Width	Quantity Locating Rings Required for Fixed	Adapter Sleeve ⁽²⁾	Labyrinth Seal ⁽³⁾	Taconite Seal ⁽³⁾	End Cover ⁽³⁾
d								
mm								
400	SNTD 3084F	23084K	FIXED HOUSING	-	OH3084H	L084	TA84	EC84
	SNTD 3084L	23084K	FLOAT HOUSING	-	OH3084H	L084	TA84	EC84
	SNTD 3184F	23184K	FIXED HOUSING	-	OH3184H	L084	TA84	EC84
	SNTD 3184L	23184K	FLOAT HOUSING	-	OH3184H	L084	TA84	EC84
410	SNTD 3088F	23088K	FIXED HOUSING	-	OH3088H	L088	TA88	EC88
	SNTD 3088L	23088K	FLOAT HOUSING	-	OH3088H	L088	TA88	EC88
	SNTD 3188F	23188K	FIXED HOUSING	-	OH3188H	L088	TA88	EC88
	SNTD 3188L	23188K	FLOAT HOUSING	-	OH3188H	L088	TA88	EC88
430	SNTD 3092F	23092K	FIXED HOUSING	-	OH3092H	L092	TA92	EC92
	SNTD 3092L	23092K	FLOAT HOUSING	-	OH3092H	L092	TA92	EC92
	SNTD 3192F	23192K	FIXED HOUSING	-	OH3192H	L092	TA92	EC92
	SNTD 3192L	23192K	FLOAT HOUSING	-	OH3192H	L092	TA92	EC92
450	SNTD 3096F	23096K	FIXED HOUSING	-	OH3096H	L096	TA96	EC96
	SNTD 3096L	23096K	FLOAT HOUSING	-	OH3096H	L096	TA96	EC96
	SNTD 3196F	23196K	FIXED HOUSING	-	OH3196H	L096	TA96	EC96
	SNTD 3196L	23196K	FLOAT HOUSING	-	OH3196H	L096	TA96	EC96
470	SNTD 30/500F	230/500K	FIXED HOUSING	-	OH30/500H	L030/500	TA30/500	EC30/500
	SNTD 30/500L	230/500K	FLOAT HOUSING	-	OH30/500H	L030/500	TA30/500	EC30/500
500	SNTD 30/530F	230/530K	FIXED HOUSING	-	OH30/530H	L030/530	TA30/530	EC30/530
	SNTD 30/530L	230/530K	FLOAT HOUSING	-	OH30/530H	L030/530	TA30/530	EC30/530

⁽¹⁾ Locating rings = sold one piece per box.

⁽²⁾ Adapter sleeve assembly includes one sleeve, one locknut and one lockwasher.

⁽³⁾ Labyrinth, taconite seal and end cover sold one seal per box.

3D CAD and 2D drawings available at <http://cad.timken.com/category/snt-housed-units>

3000 AND 3100 SERIES (CONTINUED)

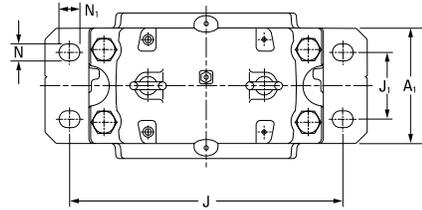
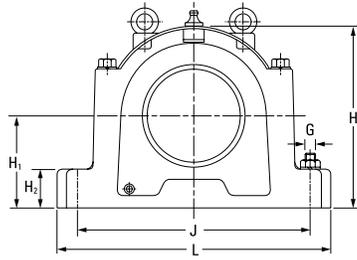

Housing Dimensions													4 Bolts Req'd	Housing Mass
A	A ₁	A ₂	A ₃	C	H	H ₁	H ₂	J	J ₁	L	N	N ₁	G	kg
mm	mm	mm	mm	mm	mm	mm	mm	mm	mm	mm	mm	mm	mm	kg
400	360	412	491.5	30	755	360	120	870	220	1040	42	50	36	597.8
400	360	412	491.5	30	755	360	120	870	220	1040	42	50	36	597.8
460	420	472	551.5	35	810	410	130	1000	260	1170	48	60	42	709.0
460	420	472	551.5	35	810	410	130	1000	260	1170	48	60	42	709.0
430	390	442	521.5	30	775	380	125	950	240	1120	48	60	42	671.7
430	390	442	521.5	30	775	380	125	950	240	1120	48	60	42	671.7
460	430	472	551.5	35	835	420	135	1030	260	1220	48	60	42	751.0
460	430	472	551.5	35	835	420	135	1030	260	1220	48	60	42	751.0
460	420	472	551.5	35	810	410	130	1000	260	1170	48	60	42	788.8
460	420	472	551.5	35	810	410	130	1000	260	1170	48	60	42	788.8
470	440	482	561.5	35	880	440	145	1070	260	1280	48	60	42	859.0
470	440	482	561.5	35	880	440	145	1070	260	1280	48	60	42	859.0
460	420	472	553	35	810	410	130	1000	260	1170	48	60	42	699.6
460	420	472	553	35	810	410	130	1000	260	1170	48	60	42	699.6
470	440	482	563	35	920	460	155	1110	260	1330	56	70	48	976.5
470	440	482	563	35	920	460	155	1110	260	1330	56	70	48	976.5
460	430	472	551.5	35	835	420	135	1030	260	1220	48	60	42	805.5
460	430	472	551.5	35	835	420	135	1030	260	1220	48	60	42	805.5
470	440	482	561.5	35	920	460	155	1110	260	1330	56	70	48	976.5
470	440	482	561.5	35	920	460	155	1110	260	1330	56	70	48	976.5

FOUR-BOLT SNTD HOUSINGS FOR CYLINDRICAL BORE BEARINGS

- The part numbers for ordering split plummer block housings and components are listed in the table below.
- Each housing includes the housing cap, housing base and cap bolts.
- Housings shown are furnished in ductile iron.
- Housings with the F suffix are manufactured for fixed bearings. Those with the L suffix are float position housings.

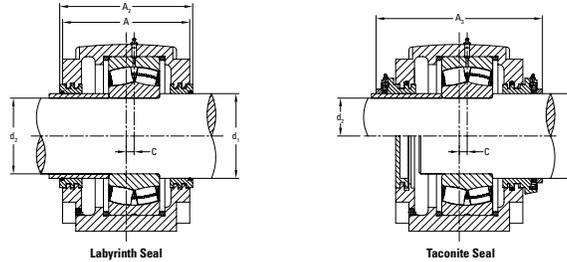

Shaft Dia.		Housing	Bearing	Locating Rings ⁽¹⁾ OD x Width	Quantity - Typically required for this bearing/housing configuration	Labyrinth Seal ⁽³⁾	Taconite Seal ⁽³⁾	End Cover ⁽³⁾
d _a	d _b							
mm	mm							
130	150	SNTD 3134	22326	SR280X7.5	2	L034	TA34	EC34
140	160	SNTD 3136	22328	SR300X7	2	L036	TA36	EC36
150	170	SNTD 3138	22330	SR320X8	2	L038	TA38	EC38
160	180	SNTD 3038	22232	SR290X17.5	2	L038/180	TA38/180	EC38
		SNTD 3038	23232	SR290X5.5	2	L038/180	TA38/180	EC38
		SNTD 3140	22332	SR340X9	2	L040	TA40	EC40
170	190	SNTD 3040	22234	SR310X18	2	L040/190	TA40/190	EC40
		SNTD 3048	22334	SR360X10	2	L048/190	TA48/190	EC48
200	220	SNTD 3048	22240	SR360X21	2	L048	TA48	EC48
		SNTD 3056	22340	SR420X14	2	L056/220	TA56/220	EC56
220	240	SNTD 3156	22344	SR460X10.5	2	L056/240	TA56/240	EC52
240	260	SNTD 3160	22348	SR500X12.5	2	L060/260	TA60/260	EC60
260	280	SNTD 3064	22252	SR480X25.5	2	L064/280	TA64/280	EC64
260	290	SNTD 3164	22352	SR540X15.5	2	L064/290	TA64/290	EC64
280	310	SNTD 3168L	22356	SR580X17.5	2	L068/310	TA68/310	EC68
360	390	SNTD 3180F	22272	SR650X25	2	L080/390	TA80/390	EC80

⁽¹⁾Locating rings = two required for fixed position, sold one piece per box.

⁽²⁾Labyrinth, taconite seal and end cover sold one seal per box.

3D CAD and 2D drawings available at <http://cad.timken.com/category/snt-housed-units>

3000 AND 3100 SERIES

- Specify bearing suffix W33 for center lubrication of groove and holes, and use the housing center port for the grease fitting.
- Grease hole fittings and plugs use 1/4 BSPT thread size
- Additional grease fittings are supplied for flexible configurations.
- Seal sleeve for d_a shaft to be supplied by customer and should have same O.D. as d_b .

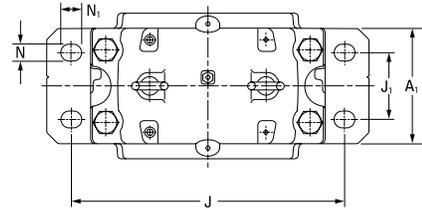
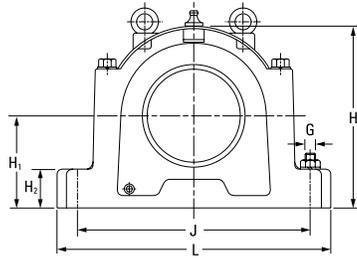

Housing Dimensions													4 Bolts Req'd	Housing Mass
A	A ₁	A ₂	A ₃	C	H	H ₁	H ₂	J	J ₁	L	N ₁	N	G	kg
mm	mm	mm	mm	mm	mm	mm	mm	mm	mm	mm	mm	mm	mm	kg
230	180	243	300	14	333	170	70	430	100	510	34	28	24	75.0
240	190	252.5	314.5	15	353	180	75	450	110	530	34	28	24	92.0
260	210	271.5	333.5	10	375	190	80	480	120	560	34	28	24	112.0
240	190	252	314	15	354	180	75	450	110	530	34	28	24	85.9
240	190	252	314	15	354	180	75	450	110	530	34	28	24	85.9
280	230	291.5	358.5	10	411	210	85	510	130	610	42	35	30	130.0
260	210	271	338	10	375	190	80	480	120	560	34	28	24	102.6
290	240	300	379.5	12	434	220	90	540	140	640	42	35	30	146.5
320	280	332.5	412	13	516	260	100	650	160	770	50	42	36	244.9
320	280	332.5	412	16	551	280	105	670	160	790	50	42	36	260.0
350	310	363	442.5	22	591	300	110	710	190	830	50	42	36	310.0
320	280	332.5	412	13	516	260	100	650	160	770	50	42	36	235.0
350	310	362.5	442	22	590	300	110	710	190	830	50	42	36	330.7
370	330	383	462.5	23	631	320	115	750	200	880	50	42	36	346.0
400	360	412	491.5	25	675	340	120	810	220	950	50	42	36	429.5
430	390	442	521.5	30	775	380	125	950	240	1120	60	48	42	595.0

SNTN HOUSINGS FOR TAPERED BORE BEARINGS

- SNTN 3000 Light Series cast iron housings are designed for large spherical roller bearings (110 - 140 mm tapered bore) used in light duty applications.
- The part numbers for ordering split plummer block housings and components are listed in the table below.

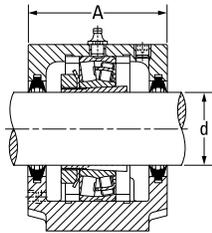

Double-Lip Seal

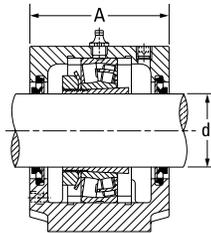

V-Ring Seal

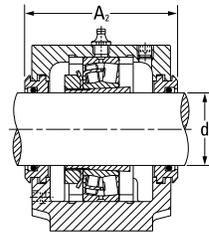

Labyrinth Seal

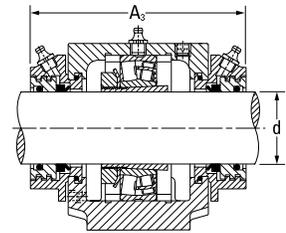

Taconite Seal

Shaft Dia.	Housing	Bearing	Locating Rings ⁽¹⁾	Adapter Sleeve ⁽²⁾	Double-Lip Seal ⁽³⁾	V-Ring Seal ⁽³⁾	Labyrinth Seal ⁽⁴⁾	Taconite Seal ⁽⁴⁾	End Cover ⁽⁴⁾
d			O.D. x Width						
mm									
110	SNTN 3024	23024K	SR180X12	H3024	TSNG524	VR524	L0524	TA524	EC524-620
115	SNTN 3026	23026K	SR200X13.5	H3026	TSNG526	VR526	L0526	TA526	EC526
125	SNTN 3028	23028K	SR210X13	H3028	TSNG528	VR528	L0528	TA528	EC528
135	SNTN 3030	23030K	SR225X15	H3030	TSNG530	VR530	L0530	TA530	EC530
140	SNTN 3032	23032K	SR240X15	H3032	TSNG532	VR532	L0532	TA532	EC532

⁽¹⁾ Locating rings = two required for fixed position, sold one piece per box.

⁽²⁾ Adapter sleeve assembly includes one sleeve, one locknut and one lockwasher.

⁽³⁾ Double-lip and V-ring seals sold two seals per box.

⁽⁴⁾ Labyrinth, taconite seal and end cover sold one seal per box.

3D CAD and 2D drawings available at <http://cad.timken.com/category/snt-housed-units>

3000 LIGHT SERIES

- Each housing includes the housing cap, housing base and cap bolts.
- Specify bearing suffix W33 for center lubrication of groove and holes, and use the housing center port for the grease fitting.
- Grease hole fittings and plugs use ¼ BSPT thread size.
- Housings shown are furnished in cast iron.

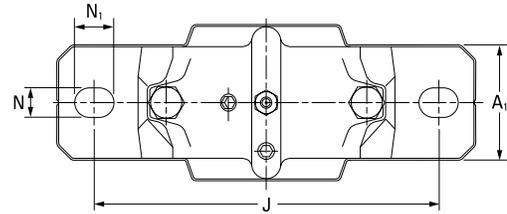
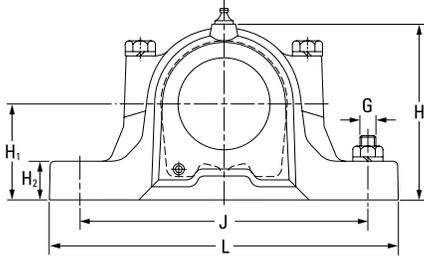

Housing Dimensions											2 Bolts Req'd	Housing Mass
A	A ₁	A ₂	A ₃	H	H ₁	H ₂	J	L	N	N ₁	G	
mm	mm	mm	mm	mm	mm	mm	mm	mm	mm	mm	mm	kg
160	110	180	240	218	112	40	320	380	26	32	24	17.0
175	120	200	245	242	125	45	350	410	26	32	24	20.0
175	120	195	255	270	140	45	350	410	26	32	24	25.0
190	130	215	265	290	150	50	380	445	28	35	24	30.0
190	130	215	270	297	150	50	390	460	28	35	24	36.0

SNTN HOUSINGS FOR CYLINDRICAL BORE BEARINGS

- SNTN 3000 Light Series cast iron housings are designed for large spherical roller bearings (120 – 175 mm cylindrical bore) used in light duty applications.
- The part numbers for ordering split plummer block housings and components are listed in the table below.
- Each housing includes the housing cap, housing base and cap bolts.

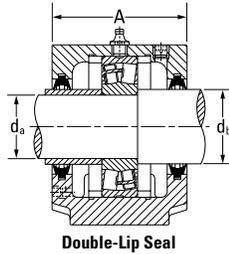

Double-Lip Seal

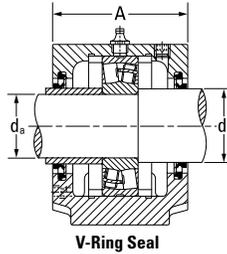

V-Ring Seal

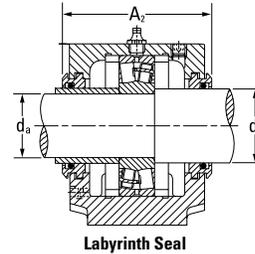

Labyrinth Seal

Shaft Dia.		Housing	Bearing	Locating Rings ⁽¹⁾ O.D. x Width	Double-Lip Seal ⁽²⁾	V-Ring Seal ⁽²⁾	Labyrinth Seal ⁽³⁾	End Cover ⁽³⁾
d _a	d _b							
mm	mm							
120	135	SNTN 3024	23024	SR180X12	TSNG224	VR224	L0224	EC524-620
		SNTN 3024	24024	SR180X5	TSNG224	VR224	L0224	EC524-620
130	145	SNTN 3026	23026	SR200X13.5	TSNG226	VR226	L0226	EC526
		SNTN 3026	24026	SR200X5	TSNG226	VR226	L0226	EC526
140	155	SNTN 3028	23028	SR210X13	TSNG228	VR228	L0228	EC528
		SNTN 3028	24028	SR210X5	TSNG228	VR228	L0228	EC528
150	165	SNTN 3030	23030	SR225X15	TSNG230	VR230	L0230	EC530
		SNTN 3030	24030	SR225X5.5	TSNG230	VR230	L0230	EC530
160	175	SNTN 3032	23032	SR240X15	TSNG232	VR232	L0232	EC532
		SNTN 3032	24032	SR240X5	TSNG232	VR232	L0232	EC532

⁽¹⁾Locating rings = two required for fixed position, sold one piece per box.

⁽²⁾Double-lip and V-ring seals sold two seals per box.

⁽³⁾Labyrinth and end cover sold one per box.

3D CAD and 2D drawings available at <http://cad.timken.com/category/snt-housed-units>

3000 LIGHT SERIES

- Specify bearing suffix W33 for center lubrication of groove and holes, and use the housing center port for the grease fitting.
- Grease hole fittings and plugs use 1/4 BSPT thread size.
- Assemblies shown are furnished in cast iron.
- Seal sleeve for d_a shaft to be supplied by customer and should have same O.D. as d_b .

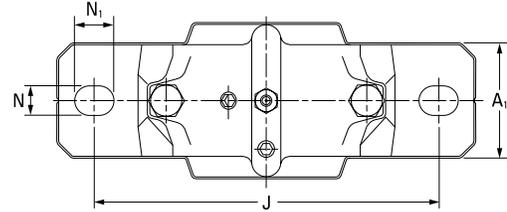
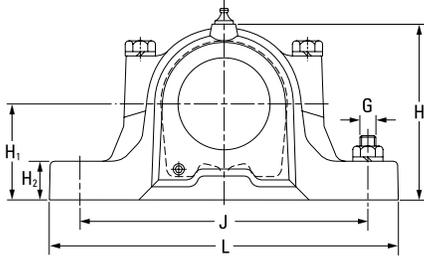

Housing Dimensions											2 Bolts Req'd	Housing Mass
A	A ₁	A ₂	A ₃	H	H ₁	H ₂	J	L	N	N ₁	G	kg
mm	mm	mm	mm	mm	mm	mm	mm	mm	mm	mm	mm	kg
160	110	180	240	218	112	40	320	380	26	32	24	17.0
160	110	180	240	218	112	40	320	380	26	32	24	17.0
175	120	200	245	242	125	45	350	410	26	32	24	20.0
175	120	200	245	242	125	45	350	410	26	32	24	20.0
175	120	195	255	270	140	45	350	410	26	32	24	25.0
175	120	195	255	270	140	45	350	410	26	32	24	25.0
190	130	215	265	290	150	50	380	445	28	35	24	30.0
190	130	215	265	290	150	50	380	445	28	35	24	30.0
190	130	215	270	297	150	50	390	460	28	35	24	36.0
190	130	215	270	297	150	50	390	460	28	35	24	36.0



TIMKEN HOUSED UNITS...SOLUTIONS HOUSED IN STRENGTH.

	Split Cylindrical Bearing	SNT/SAF Split Plummer (Pillow) Blocks	Spherical Roller Bearing Solid Block	Type E Tapered Roller Bearing	Fafnir and U Series Ball Bearing
Applications	Split-to-the-shaft design is ideal for trapped applications in high-service cost locations	Large process equipment and heavy material handling where access and contamination present challenges	Process equipment and bulk material handling where shock loads, heavy contamination and misalignment are issues	Process equipment and bulk material handling where heavy contamination and high axial loads are issues	Material handling equipment with high speeds and/or light loads
Bearing Insert	Precision cylindrical roller bearing with machined brass cage and profiled rolling elements	High-performance spherical roller bearing with tapered bore or straight bore options	High-performance spherical roller bearing with six shaft locking options	Tapered roller bearing with enhanced internal geometries	Wide-inner-ring ball bearings provide improved shaft support and increased bearing life
Shaft Size Range	40 mm to 600 mm; 1 $\frac{1}{8}$ in. to 24 in.; <i>Larger sizes available</i>	20 mm to 530 mm; 1 $\frac{1}{8}$ in. to 19 $\frac{1}{2}$ in.; <i>Larger sizes available</i>	35 mm to 180 mm; 1 $\frac{1}{8}$ in. to 7 in.; <i>Larger sizes available</i>	35 mm to 125 mm; 1 $\frac{1}{8}$ in. to 5 in.	12 mm to 90 mm; $\frac{1}{2}$ in. to 3 $\frac{15}{16}$ in.
Housing	<ul style="list-style-type: none"> Split design available in cast iron, ductile iron and cast steel 	<ul style="list-style-type: none"> Split, two-piece design Cast iron (cast steel and ductile iron available) 	<ul style="list-style-type: none"> Solid block, one-piece design Cast steel Machined feet for consistent housing location 	<ul style="list-style-type: none"> Solid block, one-piece design Cast iron 	<ul style="list-style-type: none"> Solid block, one-piece design Cast iron
Seal Options	<ul style="list-style-type: none"> Seven seal styles, including Kevlar® packing seal and aluminum triple labyrinth 	<ul style="list-style-type: none"> SNT options include double-lip, labyrinth, V-ring, and taconite SAF comes standard with labyrinth seals, options include Timken Guard (superior protection against contamination) and taconite 	<ul style="list-style-type: none"> Six seal options <ul style="list-style-type: none"> Three triple-lip seal options (superior protection against contamination) Two double-lip seal options One labyrinth seal option (for high-speed applications) Auxiliary steel end covers available 	<ul style="list-style-type: none"> High-performance seal (standard) designed for optimized lip contact 	Fafnir Ball Bearing <ul style="list-style-type: none"> Single lip (standard) Triple lip (superior protection against contamination) Labyrinth (for high-speed applications) U Series Ball Bearing <ul style="list-style-type: none"> Precision-formed flinger High-performance seal
Additional Features	<ul style="list-style-type: none"> Split housing dimensionally interchangeable with SNL/SN/SD and SAF series plummer blocks Compensates for high degree of shaft misalignment Highly effective sealing even in extremely contaminated and wet environments 	<ul style="list-style-type: none"> Push/pull-type adapter sleeves available for ease of application Components interchangeable with industry standard designs May be ordered as individual components or an assembly 	<ul style="list-style-type: none"> Multiple options to lock bearing to shaft <ul style="list-style-type: none"> Eccentric lock Set screw lock V-lock Tapered adapter lock Double adjustment nut for fixed-to-float conversions 	<ul style="list-style-type: none"> Available with set screw locking Electro-coat paint for additional corrosion protection Enhanced bearing geometries deliver highest dynamic load ratings in the industry 	Fafnir Ball Bearing <ul style="list-style-type: none"> Shaft Guard Technology (to ease and simplify installation and removal) Three shaft-locking options: set screw, eccentric and concentric U Series Ball Bearing <ul style="list-style-type: none"> Steel cage for high temperatures Hardened and ground seal land
Benefits	<ul style="list-style-type: none"> Inspection and replacement time dramatically reduced due to split-to-the-shaft design Significantly reduces downtime associated with moving equipment to change out a bearing Improves installation safety 	<ul style="list-style-type: none"> Easy-to-remove cap for bearing inspection Housings may be reused Easily converts from fixed to float in the field High-performance Timken® spherical roller bearing runs cooler for longer bearing life 	<ul style="list-style-type: none"> Quicker installation time than split housings Easily converts between fixed and float positions after installation High-performance Timken® spherical roller bearing runs cooler for longer bearing life 	<ul style="list-style-type: none"> Quicker installation time than split housings Increased useful bearing life and load capacities Double-lip seal provides industry-leading protection against contamination 	<ul style="list-style-type: none"> Corrosion-resistant options Variety of high-strength housing designs Easy installation and removal

Timken housed units are interchangeable with common industry designs. Contact your Timken sales engineer for more information.

Kelvar® is a registered trademark of E. I. du Pont de Nemours and Company or its affiliates.



INDUSTRIES AND APPLICATIONS

- Power Generation (Coal)
- Mining
- Aggregate/Cement
- Metal Mills
- Pulp & Paper/Sawmills/Forestry
- Water Treatment
- Food Processing
- Warehousing
- Movable Bridges/Structures
- Industrial Fans/Blowers

CALL ON TIMKEN

For your nearest Timken sales representative, visit www.timken.com.

TIMKEN

The Timken team applies their know-how to improve the reliability and performance of machinery in diverse markets worldwide. The company designs, makes and markets high-performance mechanical components, including bearings, belts, brakes, clutches, chain, couplings, gears and related mechanical power transmission products and services.

Stronger. By Design.

www.timken.com